



aikon



**Агрегаты электронасосные  
центробежные одноступенчатые  
с тремя подшипниками**

**NES  
NESO**

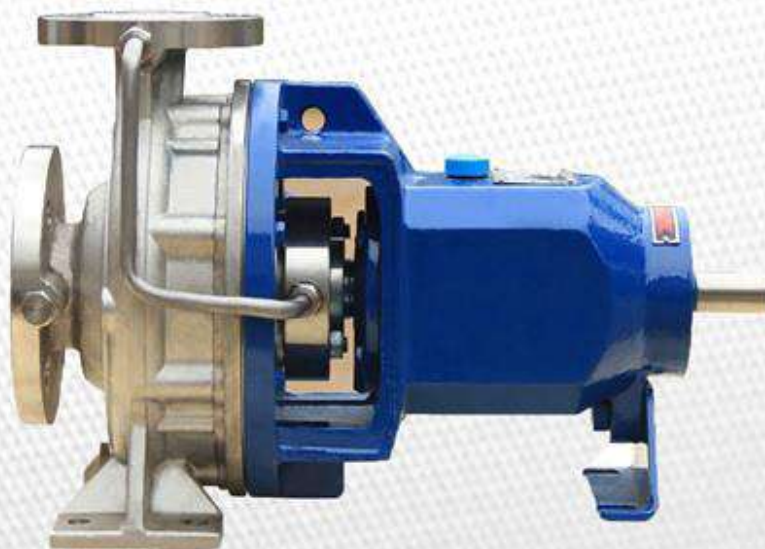

**Каталог продукции**

**Редакция от 15.07.2019**

## Оглавление

Введение.....	4
Пояснения к графическим характеристикам.....	4
Условия эксплуатации:.....	5
Расшифровка обозначения.....	6
Таблица совместимости.....	7
Шумовые характеристики агрегатов электронасосных серий NES/NESO.....	8
Конструкция насоса центробежного одноступенчатого серии NES.....	9
Габаритно-присоединительные размеры и масса агрегатов электронасосных центробежных одноступенчатых консольно-моноблочных серии NES.....	10
Конструкция насоса центробежного одноступенчатого серии NESO.....	14
Габаритно-присоединительные размеры и масса агрегатов электронасосных центробежных одноступенчатых консольно-моноблочных серии NESO.....	15
Габаритно-присоединительные размеры и масса агрегатов электронасосных центробежных одноступенчатых консольно-моноблочных серии NESO.....	16
Габаритные и присоединительные размеры фланцев всасывающего и напорного патрубков агрегатов электронасосных NES/NESO.....	24
Диапазоны рабочих характеристик.....	25
Технические характеристики насосов.....	26
Гидравлические характеристики насосов.....	54



# Насосное оборудование высокого качества



**aikon**  
насосное оборудование

Вся изготавливаемая продукция соответствует европейским стандартам:  
EN ISO 12100-1:2003, EN ISO 12100-2:2003, EN 809:1998+AC:2002,  
EN ISO 14121-1:2007, EN 60204-1:2006, EN 61000-6-2:2005, EN 61000-6-4:2007.

Директивы о соответствии:

Директива Евросоюза по машинному оборудованию: 98/37/EC, 2006/42/EC,

Директива Евросоюза по низковольтному оборудованию: 2006/95/EC,

Директива Евросоюза по электромагнитной совместимости: 2004/108/EC.

## Введение

Агрегаты электронасосные серий NES, NESO являются несамовсасывающими консольными центробежными одноступенчатыми агрегатами электронасосными с горизонтальным расположением вала ротора, осевым всасывающим и радиальным напорным патрубками. Рабочие колеса гидравлически разгружены от осевой нагрузки. Фланцы всасывающего и напорного патрубков соответствуют PN16 (16 бар) согласно EN 1092-2. Насосные части агрегатов электронасосных NES/NESO имеют защитное антикоррозионное покрытие проточной части, нанесенное методом катафореза. Конструкция агрегатов электронасосных серий NES/NESO предусматривает возможность демонтажа электродвигателя и ротора с рабочим колесом без отсоединения насосной части от трубопровода.

У агрегатов насосных серии NESO насосная часть и электродвигатель разнесены и установлены на единой жесткой стальной раме, передача вращающего момента с вала ротора электродвигателя на вал ротора насоса осуществляется за счет упругой муфты, которая в свою очередь защищена защитным кожухом во избежание нанесения травм обслуживающему персоналу.

Агрегаты насосные серии NES являются моноблочными и вращающий момент передается за счет жесткого соединения, в виду более компактной и простой конструкции.

Гибридное решение с дополнительным подшипником в насосной части во всем.

Стандартное применение главным образом включает в себя подачу в стационарных условиях чистой или слегка мутной воды с кислотностью pH-6...9 и других жидкостей, сходных с водой по плотности, вязкости и химической активности, содержащие твердые включения размером от 3.0мм до 20 мм, обычная концентрация которых не превышает 1%, не агрессивных к материалу проточной части насоса - чугуна:

- системы водоснабжения и водоподготовки;
- системы кондиционирования и отопления;
- перекачивание в системах водяного охлаждения и циркуляции;
- перекачивание производственно-хозяйственной воды;
- противопожарное оборудование;
- дождевые и ирригационные системы;
- технологические процессы.

## Пояснения к графическим характеристикам

Графические характеристики оформлены в соответствии с ISO9906.

Графики приведены для постоянной частоты вращения двигателя 2900, 1450 об/мин, при испытаниях на воде с температурой 20°C, с кинематической вязкостью 1мм<sup>2</sup>/с (1 сСт), при отсутствии в воде пузырьков воздуха.

Насосы должны использоваться в пределах рабочего интервала, указанного выделенной кривой на графике, чтобы исключить повышенный износ при высоких напорах и перегрев двигателя при больших подачах.

Если плотность и/или вязкость перекачиваемой жидкости выше, чем у воды, может потребоваться двигатель большей мощности.

**Условия эксплуатации:**

Расход	≥ 1400 м <sup>3</sup> /ч
Электрическая мощность	≥ 315 кВт
Температура перекачиваемой жидкости	-15°C до +110°C. (Температура до 140°C- по запросу)
Рабочее давление	≥ 16 бар
Входные и выходные патрубки:	-входной DN 50 ~ DN 300;
	-выходной DN 32 ~ DN 250
Стандартные насосы рассчитаны на 1,0 МПа, опционально 1,6 МПа	
Давление на подшипниках насоса: стандартно 1,6 МПа, опционально 2,4 МПа	
Стандартные насосы: BS EN733/DIN24255	
Стандартные фланцы: DIN 2501 PN16, GB/T 17241.6 PN16	
Варианты материалов основных и сменных частей агрегатов	

Таблица 1.

№ П/П	Наименование части	Наименование материала	Обозначение материала по GB	Обозначение материала по AISI
1	Корпус насоса Крышка	Серый чугун	HT250	No 30 B
		Чугун с шаровидным графитом	QT400	60-40
		Нержавеющая сталь	Cr18Ni9	304
			0Cr17Ni12Mo2	316
2	Колесо рабочее	Серый чугун	HT250	No 30 B
		Бронза	C86300	-
		Нержавеющая сталь	2Cr13	420
			Cr18Ni9	304
			0Cr17Ni12Mo2	316
3	Вал	Нержавеющая сталь	2Cr13	420
		Хромистая сталь	40Cr	5140
4	Втулка вала	Нержавеющая сталь	2Cr13	420
5	Кольцо целевое	Серый чугун	HT250	No 30 B
		Бронза	C86300	-



## Расшифровка обозначения

**NES(O)100 - 80 - 320(300) - 18,5/ 2 X X X**

S - колесо рабочее из нерж. стали
C - колесо рабочее из бронзы
H - колесо рабочее из чугуна
F - проточная часть из нерж. стали

Частота:

W - 50Гц;

L - 60Гц.

Подключение:

S - трехфазное (≤3кВт - 220/380, >3кВт - 380В);

D - однофазное, 220В;

Полярность (2-х полюсной)

Мощность электродвигателя (18,5 кВт)

Действительный диаметр колеса рабочего (мм)

Условный диаметр колеса рабочего (мм)

Диаметр напорного патрубка (мм)

Диаметр всасывающего патрубка (мм)

NES - консольно-моноблочный NESO=консольный NESV=вертикально-моноблочный



**Таблица совместимости**

Модель насоса	Номер камер подшипники	Щелевое кольцо		Подшипник	Торцевое уплотнение
		переднее	заднее		
50-32-130	25	70×10		6305ZZ/2pcs	MG1-24/ BIA24
65-40-130		80×12			
65-50-130		95×10			
80-65-130		115×12			
50-32-160	25A	70×10			
65-40-160		80×12			
65-50-160		95×10			
85-65-160		115×12			
100-80-160		130×16			
50-32-200	25	80×12			
65-40-200		80×12			
65-50-200		95×10			
85-65-200		115×12			
50-32-260	25A	80×12			
65-40-260		95×10			
65-50-260		115×12			
125-100-160	35	160×15		6307ZZ/2pcs	MG1-32/ BIA32
100-80-200		130×16			
150-125-200		180×20			
200-150-200		200×214			
125-100-200		160×15			
80-65-260		115×12			
100-80-260		130×16			
125-100-260		160×15			
150-125-260	180×20				
65-40-320	35	95×10	95×10	6307ZZ/2pcs	MG1-32/ BIA32
65-50-320		115×12	115×12		
80-65-320		130×16	125×15		
100-80-320		140×16	135×15		
125-100-320		160×15	155×15		
150-100-320	45	180×20	180×18	6309ZZ/2pcs	MG1-45/ BIA44
200-150-320		200×20	200×20		
250-200-260		200×20	235×18		
100-80-400		140×15	160×20		
125-100-400		160×15	160×20		
150-125-400		180×20	180×20		
200-150-400		200×20	180×20		
200-150-260		200×20	200×20		
65-40-320	45	95×10	95×10	6309ZZ/2pcs	MG1-45/ BIA44
65-50-320H*		115×12	115×12		
80-65-320H*		130×16	125×15		
100-80-320H*		140×16	135×16		
80-65-200H*	35	115×12		6307ZZ/2pcs	MG1-32/ BIA32
65-50-260H*		115×12			
250-200-320	55	250×18	250×18	6311ZZ/2pcs	MG1-55/ BIA55
250-200-400		235×18	235×18		
300-250-320		250×18	260×20		
300-250-400		270×18	235×18		



## Шумовые характеристики агрегатов электронасосных серий NES/NESO

2-х полюсные двигатели		4-х полюсные двигатели		
Мощность электродвигателя (кВт)	Шум (дБ) при частоте 50 Гц	Мощность электродвигателя (кВт)	Шум (дБ) при частоте 50 Гц	
0,75	-	0,55	-	
1,1	64	0,75	55	
1,5		1,1	60	
2,2		1,5	69	
3	2,2			
4	70	3	70	
5,5	74	4		
7,5		5,5	74	
11		78	7,5	71
15		83	11	
18,5			15	
22	18,5		79	
30	22			
37	86	30	76	
45	87	37		
55		45		
75		55	77	
90		75	81	
110	90			
132	94	110	87	
160		132		
200		160		
250	102	185		
315		200		
		250		



## Конструкция насоса центробежного одноступенчатого серии NES

№	Наименование
1	Корпус
2	Колесо рабочее
3	Вал
4	Крышка
5	Механическое Уплотнение
6	Уплотнение торцовое
7	Крышка Кожуха
8	Крышка Подшипника
9	Двигатель
10	Адаптер
11	Подшипник
12	Кольцо щелевое
13	Шпонка рабочего колеса
14	Гайка рабочего колеса
15	Фланец

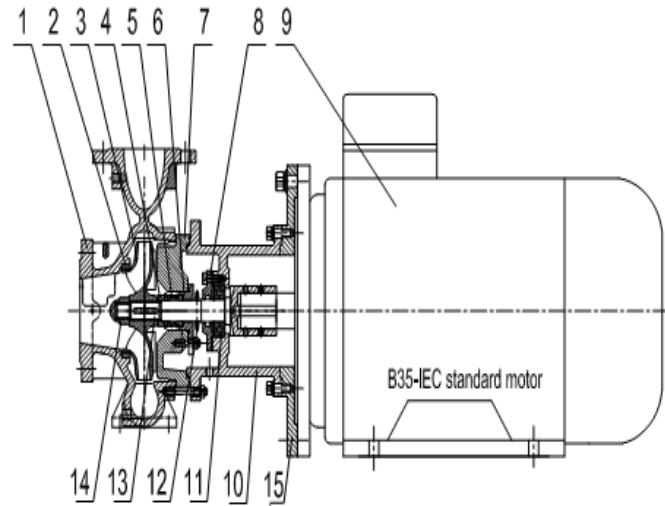

Рисунк1:Агрегат электронасосный NES

## Габаритно-присоединительные размеры и масса агрегатов электронасосных центробежных одноступенчатых консольно-моноблочных серии NES

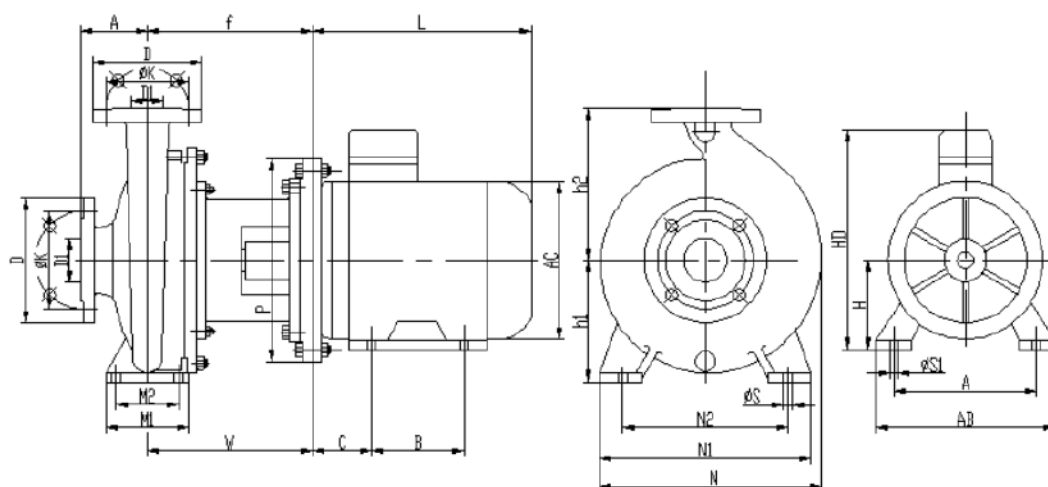

2-х полюсные, 50Гц, 2900об/мин

### Двигатель

Габарит	Мощность кВт	H	A	B	C	S1	P	AB	AC	HD	L
80	1,1	80	125	100	50	12	200	165	175	214	255
90S	1,5	90	140	100	56	12	200	180	195	250	265
90L	2,2	90	140	100	56	12	200	180	195	250	290
100L	3	100	160	140	63	15	250	205	215	270	325
112M	4	112	190	140	70	15	250	230	240	300	360
132S	5,5	132	216	140	89	15	300	270	275	345	390
132S	7,5	132	216	140	89	15	300	270	275	345	390
160M	11	160	254	210	108	19	350	320	330	420	505
160M	15	160	254	210	108	19	350	320	330	420	505
160L	18,5	160	254	254	108	19	350	320	330	420	560
180M	22	180	279	241	121	19	350	355	380	455	590
200L	30	200	318	305	133	19	400	375	420	545	660
200L	37	200	318	305	133	19	400	375	420	545	660
225M	45	225	356	311	149	19	450	435	470	555	705
250M	55	250	406	349	168	19	550	490	510	615	770
280S	75	280	457	368	190	19	550	550	580	680	845
280M	90	280	457	410	190	19	550	550	580	680	895
315S	110	315	508	406	216	24	660	635	645	845	1100
315M	132	315	508	457	216	24	660	635	645	845	1130
315L1	160	315	508	508	216	24	660	635	645	845	1210
315L2	200	315	508	508	216	24	660	635	645	845	1210

Насосная часть

Модель	Мощность				D2	D1	A	f	h1	h2	M1	M2	N	N1	N2	S	W
	1,1	1,5	2,2	3													
50-32-130	1,1	1,5	2,2		32	50	80	227	112	140	100	70	200	190	140	14	227
50-32-160	1,5	2,2	3	4	32	50	80	227	132	160	100	70	240	240	190	14	227
	5,5				32	50	80	247	132	160	100	70	240	240	190	14	247
50-32-200	5,5	7,5			32	50	80	247	160	180	100	70	275	240	190	14	247
	11				32	50	80	277	160	180	100	70	275	240	190	14	277
50-32-260	11	15	18,5		32	50	100	277	180	225	125	95	330	320	250	14	277
65-40-130	1,5	2,2	3	4	40	65	80	227	112	140	100	70	220	210	160	14	227
65-40-160	3	4			40	65	80	227	132	160	100	70	250	240	190	14	227
	5,5	7,5			40	65	80	247	132	160	100	70	250	240	190	14	247
65-40-200	5,5	7,5			40	65	100	247	160	180	100	70	280	265	212	14	247
	11				40	65	100	277	160	180	100	70	280	265	212	14	277
65-40-260	15	18,5	22		40	65	100	277	180	225	125	95	335	320	250	14	277
65-40-320	22	30	37	45	40	65	125	298	200	250	125	95	400	345	280	14	298
65-50-130	3	4			50	65	100	227	132	160	100	70	255	240	190	14	227
	5,5	7,5			50	65	100	247	132	160	100	70	255	240	190	14	247
65-50-160	5,5	7,5			50	65	100	247	160	180	100	70	275	265	212	14	247
	11				50	65	100	277	160	180	100	70	275	265	212	14	277
65-50-200	7,5	11	15	18,5	50	65	100	277	160	200	100	70	300	265	212	14	277
65-50-260H	18,5	22			50	65	100	277	180	225	125	95	340	320	250	14	277
	30	37			50	65	100	298	180	225	125	95	340	320	250	14	298
65-50-320H	30	37	45		50	65	125	298	225	280	125	95	415	345	280	14	298
	55	75			50	65	125	328	225	280	125	95	415	345	280	14	328
80-65-130	4				65	80	100	227	160	180	125	95	285	280	212	14	227
	5,5	7,5			65	80	100	247	160	180	125	95	285	280	212	14	247
80-65-160	7,5				65	80	100	247	160	200	125	95	305	280	212	14	247
	11	15	18,5		65	80	100	277	160	200	125	95	305	280	212	14	277
80-65-200H	15	18,5	22		65	80	105	277	180	225	125	95	335	320	250	14	277
	30				65	80	105	293	180	225	125	95	335	320	250	14	293
80-65-260	30	37	45		65	80	100	298	200	250	160	120	375	360	280	18	298
	55				65	80	100	328	200	250	160	120	375	360	280	18	328
80-65-320H	45				65	80	125	298	225	280	160	120	435	400	315	18	298
	55	75			65	80	125	328	225	280	160	120	435	400	315	18	328
100-80-160	11	15	18,5	22	80	100	125	277	180	225	125	95	330	320	250	14	277
	30				80	100	125	298	180	225	125	95	330	320	250	14	298
100-80-200	22				80	100	125	277	180	250	125	95	360	345	280	14	277
	30	37	45		80	100	125	298	180	250	125	95	360	345	280	14	298
100-80-260	45				80	100	125	298	200	280	160	120	410	400	315	18	298
	55	75			80	100	125	328	200	280	160	120	410	400	315	18	328
100-80-320H	75	90	110	132	80	100	125	340	200	280	160	120	410	400	315	18	340
125-100-160	15	18,5	22	30	100	125	125	298	200	250	160	120	385	360	280	18	298
125--100-200	30	37	45		100	125	125	298	200	280	160	120	390	360	280	18	298
	55	75			100	125	125	328	200	280	160	120	390	360	280	18	328
125-100-260	75				100	125	140	328	225	280	160	120	425	400	315	18	328
	90	110	132		100	125	140	340	225	280	160	120	425	400	315	18	340
125-100-320	90	110	132	200	100	125	140	340	250	315	160	120	465	400	315	18	298
150-125-200	45				80	100	125	298	180	250	125	95	360	400	280	14	298
	55	75			125	150	145	328	250	315	160	120	450	400	315	18	328
150-125-260	90	110	132	200	125	150	140	340	250	355	160	120	460	400	315	18	340



**4хполюсные, 50Гц, 1450об/мин**

**Двигатель**

Габарит	Мощность кВт	H	A	B	C	S1	P	AB	AC	HD	L
80	0,55	80	125	100	50	12	200	165	175	214	255
80	0,75	80	125	100	50	12	200	165	175	214	255
90S	1,1	90	140	100	56	12	200	180	195	250	265
90L	1,5	90	140	100	56	12	200	180	195	250	290
100L	2,2	100	160	140	63	15	250	205	215	270	325
100L	3	100	160	140	63	15	250	205	215	270	325
112M	4	112	190	140	70	15	250	230	240	300	360
132S	5,5	132	216	140	89	15	300	270	275	345	390
132M	7,5	132	216	178	89	15	300	270	275	345	430
160M	11	160	254	210	108	19	350	320	330	420	505
160L	15	160	254	254	108	19	350	320	330	420	560
180M	18,5	180	279	241	121	19	350	355	380	455	590
180L	22	180	279	279	121	19	350	355	380	455	630
200L	30	200	318	305	133	19	400	375	420	545	660
225S	37	225	356	286	149	19	450	435	470	555	675
225M	45	225	356	311	149	19	450	435	470	555	705
250M	55	250	406	349	168	19	550	490	510	615	770
280S	75	280	457	368	190	19	550	550	580	680	845
280M	90	280	457	410	190	19	550	550	580	680	895
315S	110	315	508	406	216	24	660	635	645	845	1100
315M	132	315	508	457	216	24	660	635	645	845	1130



**Насосная часть**

Модель насоса	Мощность(кВт)			D2	D1	A	f	h1	h2	M1	M2	N	N1	N2	S	W
50-32-130	0,55			32	50	80	227	112	140	100	70	200	190	140	14	227
50-32-160	0,55			32	50	80	227	132	160	100	70	240	240	190	14	227
50-32-200	0,75	1,1		32	50	80	227	160	180	100	70	275	240	190	14	227
50-32-260	2,2	3		32	50	100	227	180	225	125	95	330	320	250	14	227
65-40-130	0,55			40	65	80	227	112	140	100	70	220	210	160	14	227
65-40-160	0,55	0,75	1,1	40	65	80	227	132	160	100	70	250	240	190	14	227
65-40-200	0,75	1,1	1,5	40	65	100	227	160	180	100	70	280	265	212	14	227
65-40-260	1,5	2,2	3	40	65	100	227	180	225	125	95	335	320	250	14	227
65-40-320	4	5,5	7,5	40	65	125	268	200	250	125	95	400	345	280	14	268
65-50-130	0,55	0,75	1,1	50	65	100	227	132	160	100	70	255	240	190	14	227
65-50-160	0,75	1,1	1,5	50	65	100	227	160	180	100	70	275	265	212	14	227
65-50-200	1,1	1,5	2,2	50	65	100	227	160	200	100	70	300	265	212	14	227
65-50-260	3	4		50	65	100	227	180	225	125	95	340	320	250	14	227
	5,5		247				247									
65-50-320	5,5	7,5		50	65	125	268	225	280	125	95	415	345	280	14	268
	11		298				298									
80-65-130	0,75	1,1		65	80	100	227	160	180	125	95	285	280	212	14	227
80-65-160	1,1	1,5	2,2	65	80	100	227	160	200	125	95	305	280	212	14	227
80-65-200	2,2	3	4	65	80	105	227	180	225	125	95	335	320	250	14	227
80-65-260	3	4	5,5	65	80	100	268	200	250	160	120	375	360	280	18	268
	7,5		298				298									
80-65-320	11	15		65	80	125	268	225	280	160	120	435	400	315	18	268
80-80-160	1,5	2,2	3	80	100	125	227	180	225	125	95	330	320	250	14	227
80-80-200	3	4	5,5	80	100	125	268	180	250	125	95	360	345	280	14	268
100-80-260	7,5	11		80	100	125	298	200	280	160	120	410	400	315	18	298
100-80-320	11	15		80	100	125	298	250	315	160	120	445	400	315	18	298
100-80-400	18,5	22	30	80	100	125	319	280	355	160	120	515	440	340	18	314
125-100-160	2,2	3		100	125	125	268	200	250	160	120	385	360	280	18	268
125-100-200	5,5	7,5		100	125	125	268	200	280	160	120	390	360	280	18	268
125-100-260	11	15		100	125	140	298	225	280	160	120	425	400	315	18	298
125-100-320	15	18,5	22	100	125	140	298	250	315	160	120	465	400	315	18	298
125-100-400	22	30		100	125	140	314	280	355	200	150	550	500	400	23	314
	37		344				344									
150-125-200	7,5	11		125	150	145	298	250	315	160	120	450	400	315	18	298
150-125-260	15	18,5	22	125	150	140	298	250	355	160	120	460	400	315	18	298
150-125-320	18,5	22	30	125	150	140	314	280	355	200	150	520	500	400	23	314
150-125-400	37	45	55	125	150	160	344	315	400	200	150	560	500	400	23	344
200-150-200	11	15	18,5	150	200	160	325	280	400	200	150	460	400	315	23	325
200-150-260	18,5	22	30	150	200	160	314	280	400	200	150	485	450	350	23	314
	30		344				344									
200-150-320	37	45	55	150	200	160	344	280	400	200	150	570	550	450	23	344
200-150-400	45	55	75	150	200	160	344	315	450	200	150	610	550	450	23	344
250-200-260	22	30		200	250	180	339	315	450	200	150	590	550	450	28	339
250-200-320	37	45	55	200	250	180	379	315	480	220	170	660	600	480	28	379
	55	75	90				409									409
250-200-400	110			200	250	180	379	335	480	220	170	670	600	480	28	409
300-250-320	55	75	90	250	300	220	400	355	520	250	200	710	660	510	28	400
300-250-400	75	90		250	300	220	391	400	560	250	200	720	660	510	28	391
	110	132	421				421									

**В таблице указаны параметры основных типоразмеров агрегатов насосных в номинальной рабочей точке. Для уточнения параметров агрегата, необходимого Вам, свяжитесь с сотрудником представительства или дилером AIKON в Вашем регионе.**

## Конструкция насоса центробежного одноступенчатого серии NESO

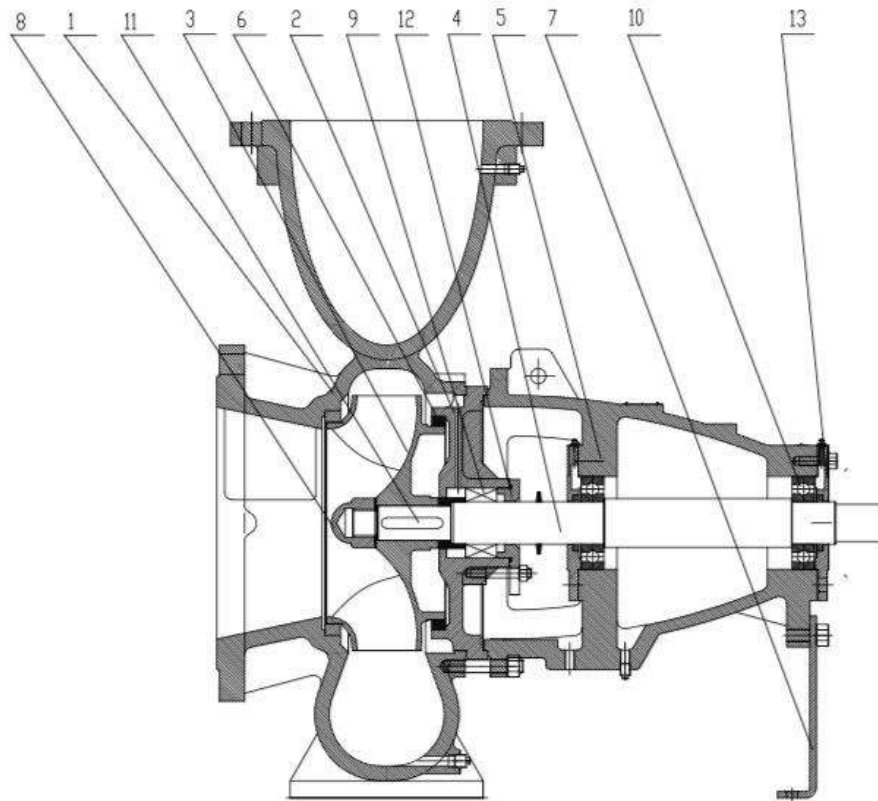

№	Наименование	Материал
1	2	3
1	Корпус	Чугун/Нержавеющая сталь
2	Крышка	Чугун/Нержавеющая сталь
3	Колесо рабочее	Чугун/Нерж. сталь/Бронза LG
4	Вал	Нержавеющая сталь/Хромистая сталь
5	Щиток защитный	Нержавеющая сталь
6	Корпус подшипникового узла	Чугун
7	Кольцо щелевое	Чугун/Бронза
8	Опора	Сталь
9	Гайка колеса рабочего	Нержавеющая сталь
10	Уплотнение торцевое	Графит/Карбид кремния
11	Подшипник качения	
12	Шпонка	Сталь
13	Крышка уплотнения торцевого	Сталь/Нержавеющая сталь
14	Крышка подшипника	Сталь/Нержавеющая сталь
15	Заглушка слива жидкости	Сталь/Нержавеющая сталь
16	Заглушка выпуска воздуха	Сталь/Нержавеющая сталь

# Габаритно-присоединительные размеры и масса агрегатов электронасосных центробежных одноступенчатых консольно-моноблочных серии NESO

## Насосная часть

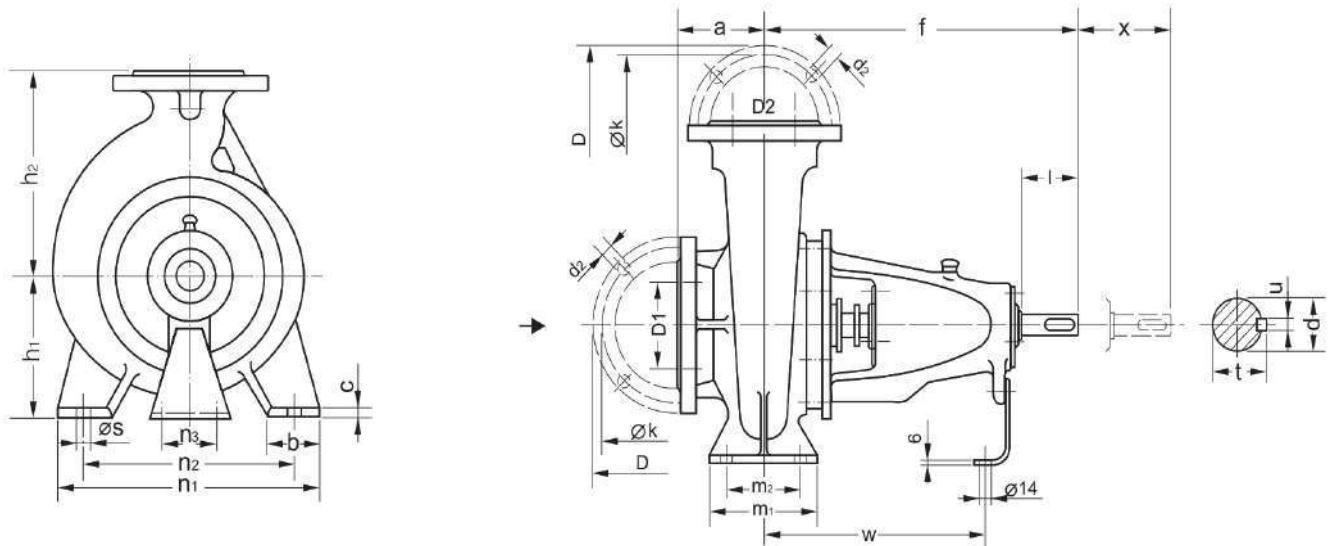

Модель	D2	D1	a	f	h1	h2	b	c	m1	m2	n1	n2	n3	s	w	d	l	t	u	x	Масса, кг
50-32-130	32	50	80	360	112	140	50	14	100	70	190	140	100	267	24	50	27	8	4	30	
50-32-160					132	160															39
50-32-200					160	180															43
50-32-260	40	100	80	360	180	225	65	14	125	95	320	250	110	267	24	50	27	8	4	62	
65-40-130					112	140	33														
65-40-160					132	160	38														
65-40-200	40	100	100	360	160	180	50	14	100	70	240	190	100	267	24	50	27	8	4	38	
65-40-260					180	225	47														
65-40-320					180	225	62														
65-40-320H	50	65	125	526	470	200	250	65	14	125	95	345	280	110	342	32	80	35	10	4	87
65-50-130					200	250	87														
65-50-160					225	280	87														
65-50-200	50	100	100	360	160	180	200	50	14	100	70	265	212	14	267	24	50	27	8	4	63
65-50-260					180	225	63														
65-50-260H					180	225	63														
65-50-320	50	65	125	526	225	280	65	14	125	95	345	280	110	342	32	80	35	10	4	87	
65-50-320H					225	280	87														
65-50-320H					225	280	87														
80-65-130	65	80	100	360	160	180	200	65	14	125	95	280	212	18	267	24	50	27	8	4	46
80-65-160					180	225	57														
80-65-200					180	225	57														
80-65-200H	65	80	105	465	180	225	80	14	160	120	400	315	110	339	32	80	35	10	4	57	
80-65-260					200	250	81														
80-65-320					200	250	98														
80-65-320H	80	100	125	526	225	280	80	14	160	120	400	315	110	342	32	80	35	10	4	98	
100-80-160					225	280	98														
100-80-200					225	280	98														
100-80-260	80	100	125	526	250	315	80	14	125	95	320	250	110	267	24	50	27	8	4	51	
100-80-320					250	315	73														
100-80-320H					250	315	73														
100-80-400	100	125	140	530	280	355	83	16	160	120	440	340	18	342	32	80	35	10	4	91	
125-100-160					280	355	103														
125-100-200					280	355	103														
125-100-260	100	125	140	530	200	250	80	16	160	120	360	280	18	342	32	80	35	10	4	103	
125-100-320					200	250	103														
125-100-320H					200	250	103														
125-100-400	100	125	140	530	250	315	80	16	200	150	500	400	23	367	42	110	45	12	4	110	
125-100-400					250	315	110														
125-100-400					250	315	110														
125-100-400	100	125	140	530	280	355	100	20	200	150	500	400	23	370	42	110	45	12	4	164	
125-100-400					280	355	164														
125-100-400					280	355	164														

Модель	D2	D1	a	f	h1	h2	b	c	m1	m2	n1	n2	n3	s	w	d	l	t	u	x	Масса, кг		
150-125-200	125	150	145	470	250	315	80	16	160	120	400	315		18	342	32	80	35	10		97		
150-125-260			355			110																	
150-125-320			140	530	280	355	18	200	150	500	400	370	42	110	45	12	158						
150-125-400					315	400				367	32	80	35	10	178								
200-150-200	150	200	160	497	280	400	100	18	200	150	400	315		23	367	32	80	35	10		154		
200-150-260				250	355	450					400	350									144		
200-150-320				530	280	400					370	42									45	12	183
200-150-400				555	315	450					550	450									206		
250-200-260	200	250	180	670	335	480	120	20	220	170	600	480		28	505	42	110	45	12		216		
250-200-320				591	355	520					392	51									14	308	
250-200-400				682	400	560					505	51									14	341	
300-250-320				250	300	220					691	355									520	150	26
300-250-400	682	400	560				516	48	51	14	453												

## Габаритно-присоединительные размеры и масса агрегатов электронасосных центробежных одноступенчатых консольно-моноблочных серии NESO

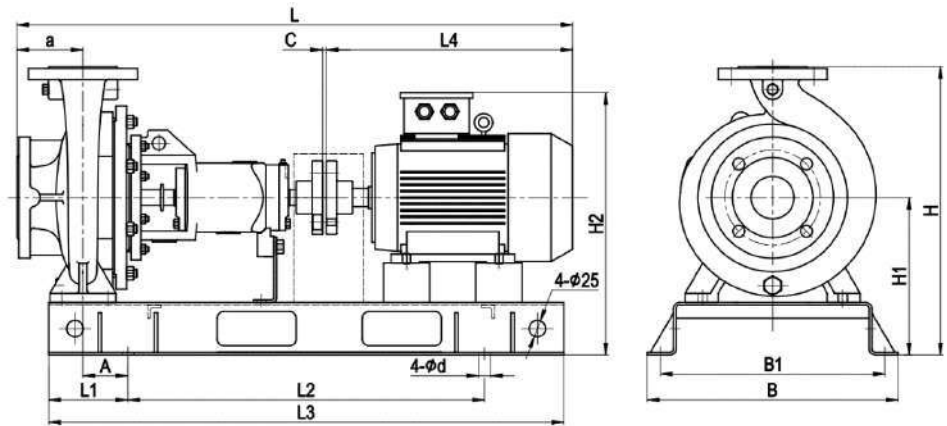

Насосный агрегат в сборе

Насос	Двигатель		Габариты (мм)														Вес(кг)	
	Модель	кВт	a	L	A	L1	L2	L3	L4	B	B1	H	H1	H2	C	φd	Двиг	Общий
50-32-130	Y2-90L-2	2,2	80	788	65	120	480	720	345	360	325	332	192	352	3	19	26	70
50-32-130	Y2-90S-2	1,5	80	763	65	120	480	720	320	360	325	332	192	352	3	19	21	66
50-32-130	Y2-802-2	1,1	80	738	65	120	480	720	295	360	325	332	192	332	3	19	17	62
50-32-130	Y2-801-2	0,75	80	738	65	120	480	720	295	360	325	332	192	332	3	19	16	61
50-32-130	Y2-801-4	0,55	80	738	65	120	480	720	295	360	325	332	192	332	3	19	16	61
50-32-160	Y2-132S1-2	5,5	80	913	65	120	540	780	470	430	395	372	212	425	3	19	65	122
50-32-160	Y2-112M-2	4	80	843	65	120	480	720	400	360	325	372	212	400	3	19	43	93
50-32-160	Y2-100L-2	3	80	828	65	120	480	720	385	360	325	372	212	382	3	19	44	94
50-32-160	Y2-90L-2	2,2	80	788	65	120	480	720	345	360	325	372	212	372	3	19	26	76
50-32-160	Y2-90S-2	1,5	80	763	65	120	480	720	320	360	325	372	212	372	3	19	21	72
50-32-160	Y2-802-4	0,75	80	738	65	120	480	720	295	360	325	372	212	352	3	19	17	68
50-32-160	Y2-801-4	0,55	80	738	65	120	480	720	295	360	325	372	212	352	3	19	16	67
50-32-200	Y2-160M1-2	11	80	1058	95	150	650	950	615	430	395	420	240	500	3	19	108	184
50-32-200	Y2-132S2-2	7,5	80	913	65	120	540	780	470	430	395	420	240	453	3	19	69	140



Насос	Двигатель		Габариты (мм)														Вес(кг)	
Модель	Модель	кВт	a	L	A	L1	L2	L3	L4	B	B1	H	H1	H2	C	φd	Двиг	Общий
50-32-200	Y2-132S1-2	5,5	80	913	65	120	540	780	470	430	395	420	240	453	3	19	65	136
50-32-200	Y2-112M-2	4	80	843	65	120	480	720	400	360	325	420	240	428	3	19	43	105
50-32-200	Y2-90S-4	1,1	80	763	65	120	480	720	320	360	325	420	240	400	3	19	22	85
50-32-200	Y2-802-4	0,75	80	738	65	120	480	720	295	360	325	420	240	380	3	19	17	80
50-32-200	Y2-801-4	0,55	80	738	65	120	480	720	295	360	325	420	240	380	3	19	16	79
50-32-260	Y2-160L-2	18,5	100	1135	84,5	150	650	950	670	430	395	485	260	520	3	19	133	222
50-32-260	Y2-160M2-2	15	100	1080	84,5	150	650	950	615	430	395	485	260	520	3	19	109	199
50-32-260	Y2-160M1-2	11	100	1080	84,5	150	650	950	615	430	395	485	260	520	3	19	108	198
50-32-260	Y2-100L2-4	3	100	850	54,5	120	540	780	385	430	395	485	260	430	3	19	37	113
50-32-260	Y2-100L1-4	2,2	100	850	54,5	120	540	780	385	430	395	485	260	430	3	19	34	110
50-32-260	Y2-90L-4	1,5	100	810	54,5	120	540	780	345	430	395	485	260	420	3	19	27	103
65-40-130	Y2-112M-2	4	80	843	65	120	480	720	400	360	325	332	192	380	3	19	43	88
65-40-130	Y2-100L-2	3	80	828	65	120	480	720	385	360	325	332	192	362	3	19	44	90
65-40-130	Y2-90L-2	2,2	80	788	65	120	480	720	345	360	325	332	192	352	3	19	26	72
65-40-130	Y2-90S-2	1,5	80	763	65	120	480	720	320	360	325	332	192	352	3	19	21	68
65-40-130	Y2-801-4	0,55	80	738	65	120	480	720	295	360	325	332	192	332	3	19	16	63
65-40-160	Y2-132S2-2	7,5	80	913	65	120	540	780	470	430	395	372	212	425	3	19	69	125
65-40-160	Y2-132S1-2	5,5	80	913	65	120	540	780	470	430	395	372	212	425	3	19	65	121
65-40-160	Y2-112M-2	4	80	843	65	120	480	720	400	360	325	372	212	400	3	19	43	92
65-40-160	Y2-100L-2	3	80	828	65	120	480	720	385	360	325	372	212	382	3	19	44	93
65-40-160	Y2-90S-4	1,1	80	763	65	120	480	720	320	360	325	372	212	372	3	19	22	72
65-40-160	Y2-802-4	0,75	80	738	65	120	480	720	295	360	325	372	212	352	3	19	17	67
65-40-160	Y2-801-4	0,55	80	738	65	120	480	720	295	360	325	372	212	352	3	19	16	66
65-40-200	Y2-160M1-2	11	100	1078	95	150	650	950	615	430	395	420	240	500	3	19	108	182
65-40-200	Y2-132S2-2	7,5	100	933	65	120	540	780	470	430	395	420	240	453	3	19	69	138
65-40-200	Y2-132S1-2	5,5	100	933	65	120	540	780	470	430	395	420	240	453	3	19	65	134
65-40-200	Y2-90L-4	1,5	100	808	65	120	480	720	345	360	325	420	240	400	3	19	27	87
65-40-200	Y2-90S-4	1,1	100	783	65	120	480	720	320	360	325	420	240	400	3	19	22	83
65-40-200	Y2-802-4	0,75	100	758	65	120	480	720	295	360	325	420	240	380	3	19	17	78
65-40-260	Y2-180M-2	22	100	1166	84,5	150	650	950	700	480	445	485	260	535	4	19	155	256
65-40-260	Y2-160L-2	18,5	100	1135	84,5	150	650	950	670	430	395	485	260	520	3	19	133	225
65-40-260	Y2-160M2-2	15	100	1080	84,5	150	650	950	615	430	395	485	260	520	3	19	109	202
65-40-260	Y2-160M1-2	11	100	1080	84,5	150	650	950	615	430	395	485	260	520	3	19	108	201
65-40-260	Y2-100L2-4	3	100	850	54,5	120	540	780	385	430	395	485	260	430	3	19	37	116
65-40-260	Y2-100L1-4	2,2	100	850	54,5	120	540	780	385	430	395	485	260	430	3	19	34	113
65-40-260	Y2-90L-4	1,5	100	810	54,5	120	540	780	345	430	395	485	260	420	3	19	27	106
65-40-320H	Y2-225M-2	45	125	1414	132,5	200	900	1300	815	570	530	555	305	640	4	24	286	445
65-40-320H	Y2-200L2-2	37	125	1369	132,5	200	800	1200	770	520	485	530	280	585	4	19	235	376



Насос		Двигатель		Габариты (мм)													Вес(кг)	
Модель	Модель	кВт	a	L	A	L1	L2	L3	L4	B	B1	H	H1	H2	C	φd	Двиг	Общий
65-40-320H	Y2-200L1-2	30	125	1369	132,5	200	800	1200	770	520	485	530	280	585	4	19	224	366
65-40-320H	Y2-180M-2	22	125	1299	132,5	200	720	1120	700	520	485	530	280	555	4	19	155	298
65-40-320	Y2-132M-4	7,5	125	1108	82,5	150	650	950	510	480	445	530	280	493	3	19	79	206
65-40-320	Y2-132S-4	5,5	125	1068	82,5	150	650	950	470	480	445	530	280	493	3	19	65	193
65-40-320	Y2-112M-4	4	125	998	82,5	150	650	950	400	480	445	530	280	468	3	19	47	174
65-40-320	Y2-100L2-4	3	125	983	82,5	150	650	950	385	480	445	530	280	450	3	19	37	164
65-50-130	Y2-132S2-2	7,5	100	933	65	120	540	780	470	430	395	372	212	425	3	19	69	126
65-50-130	Y2-132S1-2	5,5	100	933	65	120	540	780	470	430	395	372	212	425	3	19	65	122
65-50-130	Y2-112M-2	4	100	863	65	120	480	720	400	360	325	372	212	400	3	19	43	93
65-50-130	Y2-100L-2	3	100	848	65	120	480	720	385	360	325	372	212	382	3	19	44	94
65-50-130	Y2-90S-4	1,1	100	783	65	120	480	720	320	360	325	372	212	372	3	19	22	73
65-50-130	Y2-802-4	0,75	100	758	65	120	480	720	295	360	325	372	212	352	3	19	17	68
65-50-130	Y2-801-4	0,55	100	758	65	120	480	720	295	360	325	372	212	352	3	19	16	67
65-50-160	Y2-160M1-2	11	100	1078	95	150	650	950	615	430	395	420	240	500	3	19	108	176
65-50-160	Y2-132S2-2	7,5	100	933	65	120	540	780	470	430	395	420	240	453	3	19	69	132
65-50-160	Y2-132S1-2	5,5	100	933	65	120	540	780	470	430	395	420	240	453	3	19	65	128
65-50-160	Y2-112M-2	4	100	863	65	120	480	720	400	360	325	420	240	428	3	19	43	97
65-50-160	Y2-90L-4	1,5	100	808	65	120	480	720	345	360	325	420	240	400	3	19	27	81
65-50-160	Y2-90S-4	1,1	100	783	65	120	480	720	320	360	325	420	240	400	3	19	22	77
65-50-160	Y2-802-4	0,75	100	758	65	120	480	720	295	360	325	420	240	380	3	19	17	72
65-50-160	Y2-801-4	0,55	100	758	65	120	480	720	295	360	325	420	240	380	3	19	16	71
65-50-200	Y2-160L-2	18,5	100	1136	98	150	650	950	670	430	395	440	240	500	3	19	133	210
65-50-200	Y2-160M2-2	15	100	1081	98	150	650	950	615	430	395	440	240	500	3	19	109	187
65-50-200	Y2-160M1-2	11	100	1081	98	150	650	950	615	430	395	440	240	500	3	19	108	186
65-50-200	Y2-132S2-2	7,5	100	936	68	120	540	780	470	430	395	440	240	453	3	19	69	142
65-50-200	Y2-100L1-4	2,2	100	851	68	120	480	720	385	360	325	440	240	410	3	19	34	98
65-50-200	Y2-90L-4	1,5	100	811	68	120	480	720	345	360	325	440	240	400	3	19	27	91
65-50-200	Y2-90S-4	1,1	100	786	68	120	480	720	320	360	325	440	240	400	3	19	22	87
65-50-260G	Y2-200L2-2	37	100	1344	132,5	200	800	1200	770	520	485	505	280	585	4	19	235	351
65-50-260G	Y2-200L1-2	30	100	1344	132,5	200	800	1200	770	520	485	505	280	585	4	19	224	341
65-50-260G	Y2-180M-2	22	100	1274	132,5	200	720	1120	700	520	485	485	260	535	4	19	155	265
65-50-260H	Y2-200L2-2	37	100	1237	135,5	200	720	1120	770	520	485	505	280	585	4	19	235	352
65-50-260	Y2-200L1-2	30	100	1237	135,5	200	720	1120	770	520	485	505	280	585	4	19	224	342
65-50-260	Y2-180M-2	22	100	1167	85,5	150	650	950	700	480	445	485	260	535	4	19	155	263
65-50-260	Y2-160L-2	18,5	100	1136	85,5	150	650	950	670	430	395	485	260	520	3	19	133	232
65-50-260	Y2-132S-4	5,5	100	936	85,5	150	650	950	470	430	395	485	260	473	3	19	65	165
65-50-260	Y2-112M-4	4	100	866	55,5	120	540	780	400	430	395	485	260	448	3	19	47	133
65-50-260	Y2-100L2-4	3	100	851	55,5	120	540	780	385	430	395	485	260	430	3	19	37	123



Насос		Двигатель		Габариты (мм)													Вес(кг)	
Модель	Модель	кВт	a	L	A	L1	L2	L3	L4	B	B1	H	H1	H2	C	φd	Двиг	Общий
65-50-320H	Y2-280S-2	75	100	1559	182,5	250	950	1450	985	670	630	640	360	760	4	24	485	680
65-50-320H	Y2-250M-2	55	100	1484	182,5	250	860	1360	910	630	590	610	330	695	4	24	373	562
65-50-320H	Y2-225M-2	45	100	1389	132,5	200	900	1300	815	570	530	585	305	640	4	24	286	445
65-50-320H	Y2-200L2-2	37	100	1344	132,5	200	800	1200	770	520	485	585	305	610	4	19	235	386
65-50-320H	Y2-200L1-2	30	100	1344	132,5	200	800	1200	770	520	485	585	305	610	4	19	224	376
65-50-320	Y2-160M-4	11	100	1188	132,5	200	720	1120	615	520	485	585	305	565	3	19	108	248
65-50-320	Y2-132M-4	7,5	100	1083	82,5	150	650	950	510	480	445	585	305	518	3	19	79	212
65-50-320	Y2-132S-4	5,5	100	1043	82,5	150	650	950	470	480	445	585	305	518	3	19	65	199
80-65-130	Y2-160M1-2	11	100	1078	82,5	150	650	950	615	430	395	420	240	500	3	19	108	178
80-65-130	Y2-132S2-2	7,5	100	933	52,5	120	540	780	470	430	395	420	240	453	3	19	69	134
80-65-130	Y2-132S1-2	5,5	100	933	52,5	120	540	780	470	430	395	420	240	453	3	19	65	130
80-65-130	Y2-90L-4	1,5	100	808	52,5	120	540	780	345	430	395	420	240	400	3	19	27	86
80-65-130	Y2-90S-4	1,1	100	783	52,5	120	540	780	320	430	395	420	240	400	3	19	22	81
80-65-130	Y2-802-4	0,75	100	758	52,5	120	540	780	295	430	395	420	240	380	3	19	17	76
80-65-160	Y2-160M2-2	15	100	1078	82,5	150	650	950	615	430	395	440	240	500	3	19	109	185
80-65-160	Y2-160M1-2	11	100	1078	82,5	150	650	950	615	430	395	440	240	500	3	19	108	184
80-65-160	Y2-132S2-2	7,5	100	933	52,5	120	540	780	470	430	395	440	240	453	3	19	69	140
80-65-160	Y2-132S1-2	5,5	100	933	52,5	120	540	780	470	430	395	440	240	453	3	19	65	136
80-65-160	Y2-100L1-4	2,2	100	848	52,5	120	540	780	385	430	395	440	240	410	3	19	34	99
80-65-160	Y2-90L-4	1,5	100	808	52,5	120	540	780	345	430	395	440	240	400	3	19	27	92
80-65-160	Y2-90S-4	1,1	100	783	52,5	120	540	780	320	430	395	440	240	400	3	19	22	87
80-65-200	Y2-200L1-2	30	100	1234	132,5	200	720	1120	770	520	485	505	280	585	4	19	224	329
80-65-200	Y2-180M-2	22	100	1164	82,5	150	650	950	700	480	445	485	260	535	4	19	155	250
80-65-200	Y2-160L-2	18,5	100	1133	82,5	150	650	950	670	430	395	485	260	520	3	19	133	219
80-65-200	Y2-160M2-2	15	100	1078	82,5	150	650	950	615	430	395	485	260	520	3	19	109	196
80-65-200	Y2-112M-4	4	100	863	52,5	120	540	780	400	430	395	485	260	448	3	19	47	120
80-65-200	Y2-100L2-4	3	100	848	52,5	120	540	780	385	430	395	485	260	430	3	19	37	110
80-65-200	Y2-100L1-4	2,2	100	848	52,5	120	540	780	385	430	395	485	260	430	3	19	34	107
80-65-260	Y2-250M-2	55	100	1484	165	250	860	1360	910	630	590	580	330	695	4	24	373	549
80-65-260	Y2-225M-2	45	100	1389	115	200	900	1300	815	570	530	555	305	640	4	24	286	438
80-65-260	Y2-200L2-2	37	100	1344	115	200	800	1200	770	520	485	530	280	585	4	19	235	369
80-65-260	Y2-200L1-2	30	100	1344	115	200	800	1200	770	520	485	530	280	585	4	19	224	359
80-65-260	Y2-132M-4	7,5	100	1083	65	150	650	950	510	480	445	530	280	493	3	19	79	199
80-65-260	Y2-132S-4	5,5	100	1043	65	150	650	950	470	480	445	530	280	493	3	19	65	186
80-65-260	Y2-112M-4	4	100	973	65	150	650	950	400	480	445	530	280	468	3	19	47	167
80-65-320H	Y2-280M-2	90	125	1634	165	250	950	1450	1035	670	630	640	360	760	4	24	541	746
80-65-320H	Y2-280S-2	75	125	1584	165	250	950	1450	985	670	630	640	360	760	4	24	485	690
80-65-320H	Y2-250M-2	55	125	1509	165	250	860	1360	910	630	590	610	330	695	4	24	373	572

Насос		Двигатель		Габариты (мм)													Вес(кг)	
Модель	Модель	кВт	a	L	A	L1	L2	L3	L4	B	B1	H	H1	H2	C	φd	Двиг	Общий
80-65-320H	Y2-225M-2	45	125	1414	115	200	900	1300	815	570	530	585	305	640	4	24	286	455
80-65-320	Y2-160L-4	15	125	1268	115	200	720	1120	670	520	485	585	305	565	3	19	129	278
80-65-320	Y2-160M-4	11	125	1213	115	200	720	1120	615	520	485	585	305	565	3	19	108	258
80-65-320	Y2-132M-4	7,5	125	1108	115	200	720	1120	510	520	485	585	305	518	3	19	79	228
80-65-320	Y2-132S-4	5,5	125	1068	115	200	720	1120	470	520	485	585	305	518	3	19	65	215
100-80-160	Y2-180M-2	22	125	1189	82,5	150	650	950	700	480	445	485	260	535	4	19	155	248
100-80-160	Y2-160L-2	18,5	125	1158	82,5	150	650	950	670	430	395	485	260	520	3	19	133	217
100-80-160	Y2-160M2-2	15	125	1103	82,5	150	650	950	615	430	395	485	260	520	3	19	109	194
100-80-160	Y2-160M1-2	11	125	1103	82,5	150	650	950	615	430	395	485	260	520	3	19	108	193
100-80-160	Y2-100L2-4	3	125	873	52,5	120	540	780	385	430	395	485	260	430	3	19	37	108
100-80-160	Y2-100L1-4	2,2	125	873	52,5	120	540	780	385	430	395	485	260	430	3	19	34	105
100-80-160	Y2-90L-4	1,5	125	833	52,5	120	540	780	345	430	395	485	260	420	3	19	27	98
100-80-200	Y2-225M-2	45	125	1414	132,5	200	900	1300	815	570	530	555	305	640	4	24	286	427
100-80-200	Y2-200L2-2	37	125	1369	132,5	200	800	1200	770	520	485	530	280	585	4	19	235	362
100-80-200	Y2-200L1-2	30	125	1369	132,5	200	800	1200	770	520	485	530	280	585	4	19	224	352
100-80-200	Y2-180M-2	22	125	1299	132,5	200	720	1120	700	520	485	510	260	535	4	19	155	276
100-80-200	Y2-132M-4	7,5	125	1108	82,5	150	650	950	510	480	445	510	260	473	3	19	79	188
100-80-200	Y2-132S-4	5,5	125	1068	82,5	150	650	950	470	480	445	510	260	473	3	19	65	175
100-80-200	Y2-112M-4	4	125	998	82,5	150	650	950	400	480	445	510	260	448	3	19	47	156
100-80-200	Y2-100L2-4	3	125	983	82,5	150	650	950	385	480	445	510	260	430	3	19	37	146
100-80-260	Y2-280S-2	75	125	1584	165	250	950	1450	985	670	630	640	360	760	4	24	485	675
100-80-260	Y2-250M-2	55	125	1509	165	250	860	1360	910	630	590	610	330	695	4	24	373	557
100-80-260	Y2-225M-2	45	125	1414	115	200	900	1300	815	570	530	585	305	640	4	24	286	446
100-80-260	Y2-200L2-2	37	125	1369	115	200	900	1300	770	570	530	560	280	585	4	24	235	389
100-80-260	Y2-160M-4	11	125	1213	115	200	720	1120	615	520	485	560	280	540	3	19	108	243
100-80-260	Y2-132M-4	7,5	125	1108	115	200	720	1120	510	520	485	560	280	493	3	19	79	213
100-80-260	Y2-132S-4	5,5	125	1068	115	200	720	1120	470	520	485	560	280	493	3	19	65	200
100-80-260	Y2-112M-4	4	125	998	115	200	720	1120	400	520	485	560	280	468	3	19	47	182
100-80-320H	Y2-315M-2	132	125	1894	165	250	1000	1500	1295	700	660	745	430	960	4	24	949	1202
100-80-320H	Y2-315S-2	110	125	1784	165	250	1000	1500	1185	700	660	745	430	960	4	24	867	1121
100-80-320H	Y2-280M-2	90	125	1634	165	250	950	1450	1035	670	630	675	360	760	4	24	541	750
100-80-320H	Y2-280S-2	75	125	1584	165	250	950	1450	985	670	630	675	360	760	4	24	485	694
100-80-320	Y2-180M-4	18,5	125	1299	115	200	720	1120	700	520	485	645	330	605	4	19	157	320
100-80-320	Y2-160L-4	15	125	1268	115	200	720	1120	670	520	485	645	330	590	3	19	129	282
100-80-320	Y2-160M-4	11	125	1213	115	200	720	1120	615	520	485	645	330	590	3	19	108	262
100-80-320	Y2-132M-4	7,5	125	1108	115	200	720	1120	510	520	485	645	330	543	3	19	79	232
100-80-400	Y2-200L-4	30	125	1429	115	200	900	1300	770	570	530	715	360	665	4	24	240	465
100-80-400	Y2-180L-4	22	125	1399	115	200	900	1300	740	570	530	715	360	635	4	24	179	404

Насос	Двигатель		Габариты (мм)														Вес(кг)	
	Модель	Модель	кВт	a	L	A	L1	L2	L3	L4	B	B1	H	H1	H2	C	φd	Двиг
100-80-400	Y2-180M-4	18,5	125	1359	115	200	900	1300	700	570	530	715	360	635	4	24	157	383
100-80-400	Y2-160L-4	15	125	1329	115	200	900	1300	670	570	530	715	360	620	4	24	129	354
125-100-160	Y2-200L1-2	30	125	1369	115	200	800	1200	770	520	485	530	280	585	4	19	224	359
125-100-160	Y2-180M-2	22	125	1299	115	200	720	1120	700	520	485	530	280	555	4	19	155	291
125-100-160	Y2-160L-2	18,5	125	1268	115	200	720	1120	670	520	485	530	280	540	3	19	133	260
125-100-160	Y2-160M2-2	15	125	1213	115	200	720	1120	615	520	485	530	280	540	3	19	109	236
125-100-160	Y2-112M-4	4	125	998	65	150	650	950	400	480	445	530	280	468	3	19	47	167
125-100-160	Y2-100L2-4	3	125	983	65	150	650	950	385	480	445	530	280	450	3	19	37	157
125-100-160	Y2-100L1-4	2,2	125	983	65	150	650	950	385	480	445	530	280	450	3	19	34	154
125-100-200	Y2-280S-2	75	125	1584	165	250	950	1450	985	670	630	640	360	760	4	24	485	664
125-100-200	Y2-250M-2	55	125	1509	165	250	860	1360	910	630	590	610	330	695	4	24	373	546
125-100-200	Y2-225M-2	45	125	1414	115	200	900	1300	815	570	530	585	305	640	4	24	286	435
125-100-200	Y2-200L2-2	37	125	1369	115	200	800	1200	770	520	485	560	280	585	4	19	235	366
125-100-200	Y2-200L1-2	30	125	1369	115	200	800	1200	770	520	485	560	280	585	4	19	224	356
125-100-200	Y2-160M-4	11	125	1213	115	200	720	1120	615	520	485	560	280	540	3	19	108	232
125-100-200	Y2-132M-4	7,5	125	1108	65	150	650	950	510	480	445	560	280	493	3	19	79	196
125-100-200	Y2-132S-4	5,5	125	1068	65	150	650	950	470	480	445	560	280	493	3	19	65	183
125-100-200	Y2-112M-4	4	125	998	65	150	650	950	400	480	445	560	280	468	3	19	47	164
125-100-200	Y2-100L2-4	4	125	983	65	150	650	950	385	480	445	560	280	450	3	19	37	154
125-100-260H	Y2-315M-2	132	140	1909	165	250	1000	1500	1295	700	660	710	430	960	4	24	949	1190
125-100-260H	Y2-315S-2	110	140	1799	165	250	1000	1500	1185	700	660	710	430	960	4	24	867	1109
125-100-260H	Y2-280M-2	90	140	1649	165	250	950	1450	1035	670	630	640	360	760	4	24	541	738
125-100-260H	Y2-280S-2	75	140	1599	165	250	950	1450	985	670	630	640	360	760	4	24	485	682
125-100-260H	Y2-250M-2	75	140	1524	165	250	950	1450	910	670	630	610	330	695	4	24	373	571
125-100-260	Y2-160L-4	15	140	1283	115	200	720	1120	670	520	485	585	305	565	3	19	129	270
125-100-260	Y2-160M-4	11	140	1228	115	200	720	1120	615	520	485	585	305	565	3	19	108	250
125-100-260	Y2-132M-4	7,5	140	1123	115	200	720	1120	510	520	485	585	305	518	3	19	79	220
125-100-320	Y2-180L-4	22	140	1354	115	200	720	1120	740	520	485	645	330	605	4	19	179	346
125-100-320	Y2-180M-4	18,5	140	1314	115	200	720	1120	700	520	485	645	330	605	4	19	157	324
125-100-320	Y2-160L-4	15	140	1283	115	200	720	1120	670	520	485	645	330	590	3	19	129	286
125-100-320	Y2-160M-4	11	140	1228	115	200	720	1120	615	520	485	645	330	590	3	19	108	266
125-100-400	Y2-225M-4	45	140	1519	145	250	860	1360	845	630	590	715	360	695	4	24	312	577
125-100-400	Y2-225S-4	37	140	1494	145	250	860	1360	820	630	590	715	360	695	4	24	301	566
125-100-400	Y2-200L-4	30	140	1444	145	250	860	1360	770	630	590	715	360	665	4	24	240	488
125-100-400	Y2-180L-4	22	140	1414	145	250	860	1360	740	630	590	715	360	635	4	24	179	427
150-125-200	Y2-280S-2	75	140	1599	165	250	950	1450	985	670	630	675	360	760	4	24	485	692
150-125-200	Y2-250M-2	55	140	1524	165	250	860	1360	910	630	590	645	330	695	4	24	373	567
150-125-200	Y2-225M-2	45	140	1429	115	200	900	1300	815	570	530	645	330	665	4	24	286	480

Насос	Двигатель		Габариты (мм)														Вес(кг)	
Модель	Модель	кВт	a	L	A	L1	L2	L3	L4	B	B1	H	H1	H2	C	φd	Двиг	Общий
150-125-200	Y2-160M-4	11	140	1228	115	200	720	1120	615	520	485	645	330	590	3	19	108	260
150-125-200	Y2-132M-4	7,5	140	1123	115	200	720	1120	510	520	485	645	330	543	3	19	79	230
150-125-200	Y2-132S-4	5,5	140	1083	115	200	720	1120	470	520	485	645	330	543	3	19	65	217
150-125-260	Y2-180L-4	22	140	1354	115	200	720	1120	740	520	485	685	330	605	4	19	179	345
150-125-260	Y2-180M-4	18,5	140	1314	115	200	720	1120	700	520	485	685	330	605	4	19	157	323
150-125-260	Y2-160L-4	15	140	1283	115	200	720	1120	670	520	485	685	330	590	3	19	129	285
150-125-260	Y2-160M-4	11	140	1283	115	200	720	1120	670	520	485	685	330	590	3	19	108	265
150-125-320	Y2-200L-4	30	140	1444	145	250	860	1360	770	630	590	715	360	665	4	24	240	467
150-125-320	Y2-180L-4	22	140	1414	145	250	860	1360	740	630	590	715	360	635	4	24	179	406
150-125-320	Y2-180M-4	18,5	140	1374	145	250	860	1360	700	630	590	715	360	635	4	24	157	384
150-125-320	Y2-160L-4	15	140	1343	145	250	860	1360	670	630	590	715	360	620	3	24	129	346
150-125-400	Y2-280S-4	75	160	1679	145	250	950	1450	985	670	630	795	395	795	4	24	544	830
150-125-400	Y2-250M-4	55	160	1604	145	250	860	1360	910	630	590	795	395	760	4	24	383	650
150-125-400	Y2-225M-4	45	160	1539	145	250	860	1360	845	630	590	795	395	730	4	24	312	579
150-125-400	Y2-225S-4	37	160	1514	145	250	860	1360	820	630	590	795	395	730	4	24	301	568
150-125-400	Y2-200L-4	30	160	1464	145	250	860	1360	770	630	590	795	395	700	4	24	240	490
150-125-500	Y2-315L1-4	160	160	2159	145	250	1300	1810	1325	700	660	920	470	1000	4	24	1020	1485
150-125-500	Y2-315M-4	132	160	2159	145	250	1200	1740	1325	700	660	920	470	1000	4	24	979	1440
150-125-500	Y2-315S-4	110	160	2049	145	250	1200	1740	1215	700	660	920	470	1000	4	24	836	1297
150-125-500	Y2-280M-4	90	160	1869	145	250	1140	1650	1035	730	690	885	435	835	4	24	587	1008
150-125-500	Y2-280S-4	75	160	1819	145	250	1140	1650	985	730	690	885	435	835	4	24	544	965
200-150-260	Y2-180M-4	18,5	160	1394	95	200	900	1300	700	570	530	685	330	605	4	24	157	386
200-150-260	Y2-160L-4	15	160	1393	95	200	900	1300	700	570	530	685	330	590	3	24	129	348
200-150-320	Y2-250M-4	55	160	1609	146	250	950	1450	910	670	630	760	360	725	4	24	383	648
200-150-320	Y2-225M-4	45	160	1544	146	250	950	1450	845	670	630	760	360	695	4	24	312	578
200-150-320	Y2-225S-4	37	160	1519	146	250	950	1450	820	670	630	760	360	695	4	24	301	566
200-150-320	Y2-200L-4	30	160	1469	146	250	950	1450	770	670	630	760	360	665	4	24	240	488
200-150-320	Y2-180L-4	22	160	1439	146	250	950	1450	740	670	630	760	360	635	4	24	179	427
200-150-400	Y2-280S-4	75	160	1679	145	250	950	1450	985	670	630	845	395	795	4	24	544	859
200-150-400	Y2-250M-4	55	160	1604	145	250	950	1450	910	670	630	845	395	760	4	24	383	685
200-150-400	Y2-225M-4	45	160	1539	145	250	950	1450	845	670	630	845	395	730	4	24	312	615
200-150-400	Y2-225S-4	37	160	1514	145	250	950	1450	820	670	630	845	395	730	4	24	301	603
250-200-260	Y2-200L-4	30	180	1509	145	250	950	1450	770	670	630	845	395	700	4	24	240	537
250-200-260	Y2-180L-4	22	180	1479	145	250	950	1450	740	670	630	845	395	670	4	24	179	476
250-200-260	Y2-180M-4	18,5	180	1439	145	250	950	1450	700	670	630	845	395	670	4	24	157	455
250-200-320	Y2-280S-4	75	180	1839	135	250	1140	1650	985	730	690	875	395	795	4	24	544	951
250-200-320	Y2-250M-4	55	180	1764	135	250	1140	1650	910	730	690	875	395	760	4	24	383	777
250-200-320	Y2-225M-4	45	180	1699	135	250	1140	1650	845	730	690	875	395	730	4	24	312	707



Насос		Двигатель		Габариты (мм)													Вес(кг)	
Модель	Модель	кВт	a	L	A	L1	L2	L3	L4	B	B1	H	H1	H2	C	φd	Двиг	Общий
250-200-320	Y2-225S-4	37	180	1674	135	250	1140	1650	820	730	690	875	395	730	4	24	301	696
250-200-320	Y2-200L-4	30	180	1624	135	250	1140	1650	770	730	690	875	395	700	4	24	240	617
250-200-400	Y2-315S-4	110	180	2070	120	250	1200	1770	1215	700	660	930	450	980	4	24	836	1324
250-200-400	Y2-280M-4	90	180	1890	120	250	1140	1650	1035	730	690	895	415	815	4	24	587	1036
250-200-400	Y2-280S-4	75	180	1840	120	250	1140	1650	985	730	690	895	415	815	4	24	544	993
250-200-400	Y2-250M-4	55	180	1765	120	250	1140	1650	910	730	690	895	415	780	4	24	383	819
300-250-320	Y2-280M-4	90	220	1950	120	250	1100	1650	1035	700	660	990	470	870	4	24	587	1110
300-250-320	Y2-280S-4	75	220	1900	120	250	1100	1650	985	700	660	990	470	870	4	24	544	1067
300-250-320	Y2-250M-4	55	220	1825	120	250	1000	1530	910	670	630	990	470	835	4	24	383	893
300-250-320	Y2-225M-4	45	220	1760	120	250	1000	1470	845	670	630	990	470	805	4	24	312	822
300-250-320	Y2-225S-4	37	220	1735	120	250	1000	1470	820	670	630	990	470	805	4	24	301	811
300-250-400	Y2-315M-4	132	220	2231	120	250	1200	1760	1325	700	660	1075	515	1045	4	24	979	1538
300-250-400	Y2-315S-4	110	220	2121	120	250	1200	1760	1215	700	660	1075	515	1045	4	24	836	1395
300-250-400	Y2-280M-4	90	220	1941	120	250	1100	1640	1035	700	660	1075	515	915	4	24	587	1141
300-250-400	Y2-280S-4	75	220	1891	120	250	1100	1640	985	700	660	1075	515	915	4	24	544	1099

**В таблице указаны параметры основных типоразмеров агрегатов насосных в номинальной рабочей точке. Для уточнения параметров агрегата, необходимого Вам, свяжитесь с сотрудником представительства или дилером AIKON в Вашем регионе.**

## Габаритные и присоединительные размеры фланцев всасывающего и напорного патрубков агрегатов электронасосных NES/NESO

DN	C	n- $\emptyset$	D
$\emptyset 32$	$\emptyset 100$	4 $\emptyset$ -18	$\emptyset 140$
$\emptyset 40$	$\emptyset 110$	4 $\emptyset$ -18	$\emptyset 150$
$\emptyset 50$	$\emptyset 125$	4 $\emptyset$ -18	$\emptyset 165$
$\emptyset 65$	$\emptyset 145$	4 $\emptyset$ -18	$\emptyset 185$
$\emptyset 80$	$\emptyset 160$	8 $\emptyset$ -18	$\emptyset 200$
$\emptyset 100$	$\emptyset 180$	8 $\emptyset$ -18	$\emptyset 220$
$\emptyset 125$	$\emptyset 210$	8 $\emptyset$ -18	$\emptyset 250$
$\emptyset 150$	$\emptyset 240$	8 $\emptyset$ -22	$\emptyset 285$
$\emptyset 200$	$\emptyset 295$	12 $\emptyset$ -22	$\emptyset 340$
$\emptyset 250$	$\emptyset 355$	12 $\emptyset$ -25	$\emptyset 405$
$\emptyset 300$	$\emptyset 410$	12 $\emptyset$ -26	$\emptyset 460$
$\emptyset 350$	$\emptyset 470$	16 $\emptyset$ -26	$\emptyset 520$

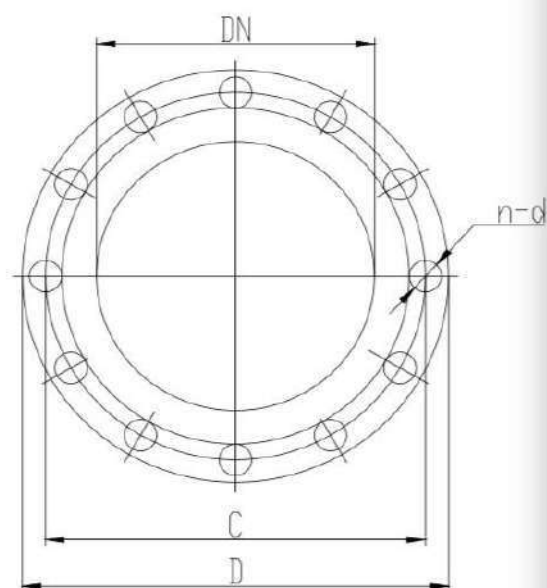

Все размеры приведены в мм.

Характеристика электродвигателей, применяемых в агрегатах электронасосных типа NES/NESO:

- стандартный асинхронный двигатель;
- степень защиты: Ip54;
- класс изоляции: F;
- класс энергоэффективности: IE2 (IE3 по запросу);
- стандартное напряжение при частоте 50Гц (60Гц по запросу);
- трехфазное исполнение (до 3кВт): 220/380В;
- трехфазное исполнение (более 3 кВт): 380/660В.



Диапазоны рабочих характеристик

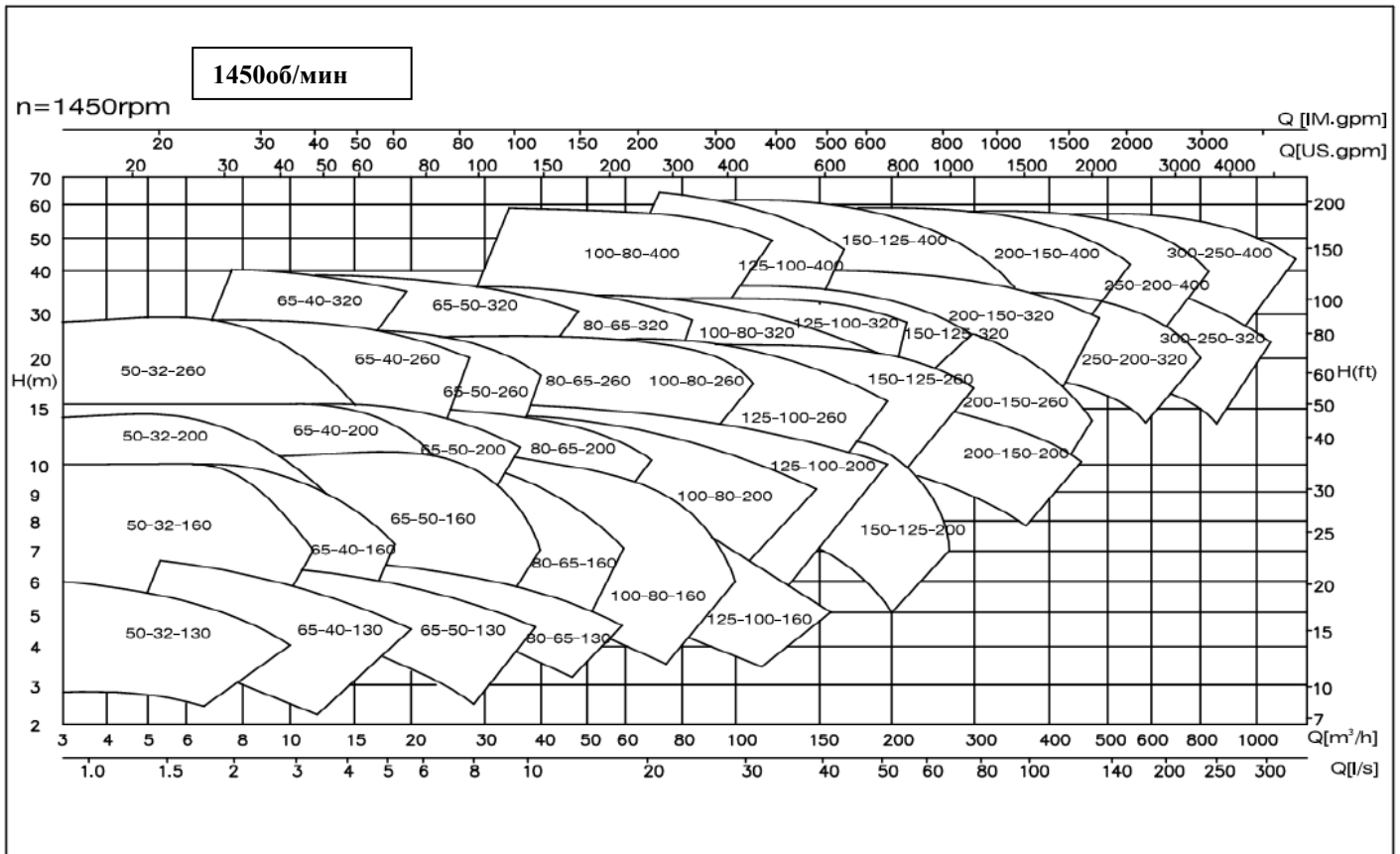

**2900об/мин**

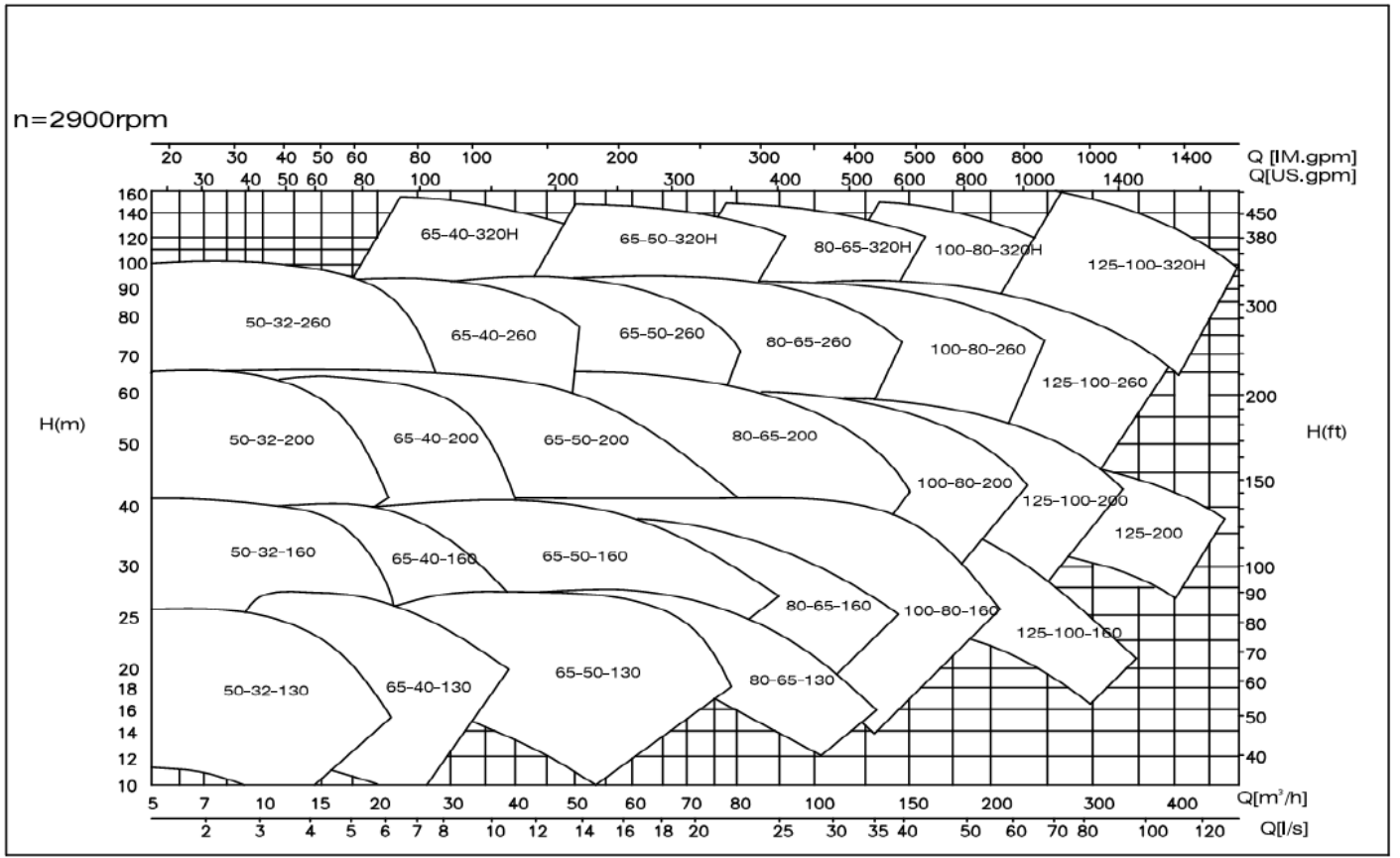

**Технические характеристики насосов**

2х полюсные, 50Гц, 2900 об/мин

Модель	Расход		Напор	Скорость	Мощность		модель двигателя	КПД	NPS HR	Рабочее колесо	Диаметр фланца	
					На валу	Двиг.					Вход	Выход
	м3/ч	л/с	М	Об/мин	кВт	кВт	%	м	мм	мм	мм	
50-32-130	9,0	2,5	24,5	2900	1,23	1,5	Y90L-2	49	1,8	139	50	32
	15,0	4,2	22,0		1,47	2,2	2.2KW	61	2			
	18,0	5,0	20,0		1,58	2,2		62	2,5			
50-32-130	8,5	2,4	21,2		1,04	1,5	Y90L-2	47	1,8	130		
	14,0	3,9	19,0		1,23	1,5	2.2KW	59	1,95			
	17,0	4,7	17,2		1,32	2,2		60,5	2,3			
50-32-130	7,8	2,2	18,0		0,89	1,1	Y90S-2	43	1,8	120		
	13,0	3,6	16,2		1,01	1,1	1.5KW	56,5	1,88			
	15,5	4,3	14,7		1,07	1,5		58	2,08			
50-32-130	7,2	2,0	15,1		0,72	1,1	Y8022	41	1,8	110		
	11,9	3,3	13,6		0,81	1,1	1.1KW	54,5	1,88			
	14,2	3,9	12,4		0,85	1,1		56	2,08			
50-32-130	6,5	1,8	12,5		0,57	0,75	Y8022	39	1,8	100		
	10,8	3,0	11,2		0,63	0,75	1.1KW	52,5	1,88			
	12,9	3,6	10,2		0,97	1,1		37	2,08			
50-32-160	11,0	3,1	40,0		2,50	3	Y132S <sub>1</sub> -2	48	1,9	174		
	18,0	5,0	37,0		3,18	4	5.5KW	57	2			
	22,0	6,1	34,0		3,51	5,5		58	2,6			
50-32-160	10,5	2,9	35,7	2,22	3	Y112M-2	46	1,9	165			
	17,0	4,7	33,0	2,78	3	4KW	55	1,95				
	21,0	5,8	30,0	3,06	4		56	2,4				
50-32-160	9,8	2,7	31,4	1,93	2,2	Y112M-2	43,5	1,9	155			
	16,0	4,4	29,0	2,38	3	4KW	53	1,95				
	19,5	5,4	26,5	2,61	4		54	2,2				
50-32-160	9,2	2,5	27,5	1,65	2,2	Y100L-2	41,5	1,9	145			
	15,0	4,2	25,4	2,03	3	3KW	51	1,95				
	18,2	5,1	23,2	2,21	3		52	2,2				
50-32-160	8,5	2,4	22,0	1,28	2,2	Y90L-2	40	1,9	135			
	13,9	3,9	20,1	1,56	2,2	2.2KW	49	1,95				
	17,0	4,7	19,1	1,76	2,2		50	2,2				
50-32-160	7,9	2,2	18,9	1,03	1,1	Y90S-2	39,5	1,9	125			
	13,0	3,6	17,2	1,26	1,5	1.5KW	48,5	1,95				
	15,8	4,4	16,4	1,42	1,5		49,5	2,2				
50-32-200	11,0	3,1	63,0	4,72	5,5	Y160M <sub>1</sub> -2	40	1,8	214			
	18,0	5,0	59,0	5,90	7,5	11KW	49	2				
	22,0	6,1	55,5	6,52	11		51	2,3				
50-32-200	10,5	2,9	57,2	4,24	5,5	Y132S <sub>2</sub> -2	38,6	1,8	205			
	17,0	4,7	54,0	5,26	7,5	7.5KW	47,5	1,95				
	21,0	5,8	50,2	5,80	7,5		49,5	2,2				
50-32-200	10,0	2,8	51,5	3,69	5,5	Y132S <sub>2</sub> -2	38	1,8	195			
	16,5	4,6	48,0	4,61	7,5	7.5KW	46,8	1,9				
	20,0	5,6	45,0	5,02	7,5		48,8	2,15				



Модель	Расход		Напор	Скорость	Мощность		модель двигателя	КПД	NPS HR	Рабочее колесо	Диаметр фланца	
					На валу	Двиг.					Вход	Выход
	м3/ч	Л/с	М	Об/мин	кВт	кВт	%	м	мм	мм	мм	
50-32-200	9,5	2,6	46,4	2900	3,24	4	Y132S <sub>1</sub> -2	37	1,8	185	50	32
	15,7	4,3	43,2		4,02	5,5	5.5KW	46	1,9			
	19,0	5,3	40,5		4,38	5,5		48	2,15			
50-32-200	9,0	2,5	41,5		2,81	4	Y132S <sub>1</sub> -2	36	1,8	175		
	14,8	4,1	38,7		3,46	5,5	5.5KW	45	1,9			
	17,9	5,0	36,2		3,77	5,5		47	2,15			
50-32-200	8,5	2,4	37,3		2,43	2,2	Y112M-2	36	1,8	165		
	14,0	3,9	34,8		2,99	4	4KW	45	1,9			
	17,0	4,7	32,6		3,25	4		47	2,15			
50-32-260	14,0	3,9	99,0	11,26	15	Y160L-2	34	2,1	264			
	22,0	6,1	95,0	13,23	15	18.5KW	43	2,2				
	26,0	7,2	92,0	14,47	18,5		45	2,6				
50-32-260	13,5	3,8	91,8	10,74	15	Y160M <sub>2</sub> -	31	2,1	255			
	21,0	5,8	88,0	12,58	15	15KW	40	2,2				
	25,0	6,9	85,0	13,61	15		43	2,5				
50-32-260	13,0	3,6	84,5	9,97	15	Y160M <sub>2</sub> -	30	2,15	245			
	20,5	5,7	81,0	11,74	15	15KW	39	2,16				
	24,0	6,7	78,4	12,62	15		41	2,38				
50-32-260	12,5	3,5	77,7	9,10	15	Y160M <sub>2</sub> -	29	2,15	235			
	19,7	5,5	74,5	10,50	15	15KW	38	2,16				
	23,0	6,4	72,1	11,30	15		40	2,38				
50-32-260	11,9	3,3	71,3	8,27	11	Y160M <sub>2</sub> -	28	2,15	225			
	18,8	5,2	68,3	9,46	15	15KW	37	2,16				
	22,0	6,1	66,1	10,17	15		39	2,38				
50-32-260	11,4	3,2	65,1	7,36	11	Y160M <sub>1</sub> -	28	2,15	215			
	18,0	5,0	62,4	8,39	11	11KW	37	2,16				
	21,1	5,9	60,4	9,01	11		39	2,38				
65-40-130	18,0	5,0	25,5	2,08	2,2	Y112M-2	60	1,8	139			
	30,0	8,3	23,5	2,74	3	4KW	70	2				
	36,0	10,0	21,5	3,03	4		70	2,4				
65-40-130	16,8	4,7	22,0	1,80	2,2	Y112M-2	56	1,8	130			
	28,0	7,8	20,2	2,30	3	4KW	67	2				
	33,6	9,3	18,8	2,56	4		67	2,25				
65-40-130	15,5	4,3	18,5	1,47	1,5	Y100L-2	53	1,8	120			
	26,0	7,2	17,0	1,85	2,2	3KW	65	1,9				
	31,0	8,6	15,5	2,01	3		65	2,15				
65-40-130	14,2	3,9	15,5	1,18	1,5	Y90L-2	51	1,8	110			
	23,8	6,6	14,3	1,47	1,5	2.2KW	63	1,9				
	28,4	7,9	13,0	1,60	2,2		63	2,15				
65-40-130	12,9	3,6	12,8	0,90	1,5	Y90L-2	50	1,8	100			
	21,7	6,0	11,8	1,12	1,5	1.5KW	62	1,9				
	25,8	7,2	10,8	1,22	1,5		62	2,15				



Модель	Расход		Напор	Скорость	Мощность		модель двигателя	КПД	NPS HR	Рабочее колесо	Диаметр фланца		
					На валу	Двиг.					Вход	Выход	
	м3/ч	Л/с	М	Об/мин	кВт	кВт	%	м	мм	мм	мм		
65-40-160	18,0	5,0	39,5	2900	3,65	5,5	Y132S <sub>2</sub> -2	53	2,1	174	65	40	
	30,0	8,3	35,0		4,47	5,5	7.5KW	64	2,5				
	36,0	10,0	31,5		4,90	7,5		63	3,6				
65-40-160	17,0	4,7	34,8		3,16	4	Y132S <sub>1</sub> -2	51	2,1	165			
	28,5	7,9	30,5		3,82	5,5	5.5KW	62	2,5				
	34,0	9,4	27,6		4,19	5,5		61	3,25				
65-40-160	16,0	4,4	30,5		2,77	4	Y112M-2	48	2,05	155			
	26,5	7,4	27,0		3,93	4	4KW	50	2,4				
	32,0	8,9	24,0		3,54	4		59	2,9				
65-40-160	15,0	4,2	26,7		2,31	3	Y112M-2	47	2,05	145			
	24,8	6,9	23,6		3,29	4	4KW	49	2,4				
	29,9	8,3	21,0		2,95	4		58	2,9				
65-40-160	13,9	3,9	23,1		1,91	3	Y100L-2	46	2,05	135			
	23,1	6,4	20,5		2,71	3	3KW	48	2,4				
	27,9	7,7	18,2		2,42	3		57	2,9				
65-40-160	12,9	3,6	19,8		1,53	3	Y100L-2	46	2,05	125			
	21,4	5,9	17,6		2,17	3	3KW	47	2,4				
	25,8	7,2	15,6		1,94	3		57	2,9				
65-40-200	18,0	5,0	63,0		2900	6,30	7,5	Y160M <sub>1</sub> -	49	1,8	214	65	40
	30,0	8,3	58,0			8,17	11	11KW	58	2			
	36,0	10,0	53,0			8,96	11		58	2,7			
65-40-200	17,0	4,7	57,4	5,72		7,5	Y160M <sub>1</sub> -	46	1,8	205			
	29,0	8,1	52,4	7,45		11	11KW	56	1,95				
	34,5	9,6	48,0	8,05		11		56	2,45				
65-40-200	16,5	4,6	51,8	5,29		5,5	Y160M <sub>1</sub> -	44	1,8	195			
	27,5	7,6	47,5	6,71		7,5	11KW	53	1,9				
	33,0	9,2	43,3	7,23		11		54	2,2				
65-40-200	15,7	4,3	46,6	4,62		7,5	Y132S <sub>2</sub> -2	43	1,8	185			
	26,1	7,2	42,8	5,84		7,5	7.5KW	52	1,9				
	31,3	8,7	39,0	6,29		7,5		53	2,2				
65-40-200	14,8	4,1	41,7	4,00		5,5	Y132S <sub>2</sub> -2	42	1,8	175			
	24,7	6,9	38,3	5,04		7,5	7.5KW	51	1,9				
	29,6	8,2	34,9	5,43		7,5		52	2,2				
65-40-200	14,0	3,9	37,1	3,40		5,5	Y132S <sub>2</sub> -2	42	1,8	165			
	23,3	6,5	34,0	4,27		7,5	7.5KW	51	1,9				
	27,9	7,8	31,0	4,59		7,5		51	2,2				
65-40-260	20,0	5,6	97,0	2900		13,20	15	Y180M <sub>1</sub> -	40	1,8	264	65	40
	33,0	9,2	92,0			16,21	18,5	22KW	51	2,0			
	40,0	11,1	87,0			17,87	22		53	2,5			
65-40-260	19,5	5,4	89,0		12,27	15	Y160L-2	39	1,8	255			
	32,0	8,9	84,0		15,09	18,5	18.5KW	49	1,95				
	38,5	10,7	79,5		16,34	18,5		51	2,35				



Модель	Расход		Напор	Скорость	Мощность		коэффициент двигателя	КПД	NPS HR	Рабочее колесо	Диаметр фланца	
					На валу	Двиг.					Вход	Выход
	м³/ч	л/с	М	Об/мин	кВт	кВт	%	м	мм	мм	мм	
65-40-260	18,5	5,1	82,0	2900	11,16	15	Y160L-2	37	1,8	245	65	40
	30,5	8,5	78,0		13,78	15	18.5KW	47	1,9			
	37,0	10,3	73,0		15,01	18,5		49	2,2			
65-40-260	17,7	4,9	75,4		10,12	15	Y160L-2	36	1,8	235		
	29,3	8,1	71,8		12,42	18,5	18.5KW	46	1,9			
	35,5	9,9	67,2		13,52	18,5		48	2,2			
65-40-260	17,0	4,7	69,2		9,14	11	Y160M-2	35	1,8	225		
	28,0	7,8	65,8		11,15	15	15KW	45	1,9			
	34,0	9,4	61,6		12,12	15		47	2,2			
65-40-320H	21,6	6,0	155,0	28,04	30	Y225M-2	33	5,05	329			
	36,0	10,0	147,0	34,30	37	45KW	42	4,8				
	43,2	12,0	140,0	37,42	45		44	5,2				
65-40-320H	20,5	5,7	137,0	24,66	30	Y200L-2	31	5,05	315			
	34,5	9,6	130,0	30,52	37	37KW	40	4,9				
	41,4	11,5	124,0	33,27	37		42	5				
65-40-320H	19,8	5,5	122,0	22,29	30	Y200L-2	30	5,1	300			
	32,4	9,0	117,0	27,89	30	37KW	37	4,9				
	39,6	11,0	112,0	30,96	37		39	5				
65-40-320H	18,7	5,2	110,0	20,36	22	Y200L-2	28	5,1	285			
	31,5	8,8	105,0	25,01	30	30KW	36	4,9				
	37,5	10,4	100,0	26,66	30		38	4,9				
65-40-320H	17,5	4,9	95,0	18,10	22	Y200L-2	25	5,15	270			
	29,5	8,2	90,0	21,26	30	30KW	34	4,9				
	35,5	9,9	85,0	22,82	30		36	4,8				
65-40-320H	18,7	4,7	85,0	18,10	18,5	Y180M-2	24	5,15	255			
	27,9	7,8	80,0	18,41	22	22KW	33	4,9				
	33,5	9,3	75,0	18,54	22		35	4,9				
65-50-130	36,0	10,0	25,5	3,84	5,5	Y132S-2	65	2,5	139			
	60,0	16,7	23,0	4,94	5,5	7.5KW	76	3,2				
	72,0	20,0	20,5	5,36	7,5		75	4				
65-50-130	33,5	9,3	22,0	3,16	4	Y132S-2	63	2,5	130			
	56,0	15,6	19,5	4,02	5,5	5.5KW	74	3,1				
	67,5	18,8	17,2	4,33	5,5		73	3,6				
65-50-130	31,0	8,6	18,5	2,56	3	Y132S-2	61	2,5	120			
	52,0	14,4	16,5	3,24	4	5.5KW	72	2,9				
	62,0	17,2	14,8	3,52	5,5		71	3,3				
65-50-130	28,4	7,9	15,5	2,00	3	Y112M-2	60	2,5	110			
	47,7	13,2	13,9	2,53	4	4KW	71	2,9				
	56,8	15,8	12,4	2,75	4		70	3,3				
65-50-160	40,0	11,1	41,5	7,06	11	Y160M-2	64	2,5	174			
	65,0	18,1	38,0	9,09	11	11KW	74	3,5				
	78,0	21,7	35,0	10,04	11		74	4,2				



Модель	Расход		Напор	Скорость	Мощность		модель двигателя	КПД	NPS HR	Рабочее колесо	Диаметр фланца	
					На валу	Двиг.					Вход	Выход
	м3/ч	Л/с	М	Об/мин	кВт	кВт	%	м	мм	мм	мм	
65-50-160	38,0	10,6	37,0	2900	6,17	7,5	Y160M <sub>1</sub> -11KW	62	2,5	165	65	50
	61,5	17,1	33,8		7,86	11		72	3,3			
	74,0	20,6	31,2		8,73	11		72	3,9			
65-50-160	35,5	9,9	32,5		5,23	5,5	Y160M <sub>1</sub> -11KW	60	2,35	155		
	58,0	16,1	29,5		6,65	11		70	3,1			
	69,5	19,3	27,0		7,35	11		70	3,7			
65-50-160	33,2	9,2	28,4		4,36	5,5	Y132S <sub>2</sub> -2 7.5KW	59	2,35	145		
	54,3	15,1	25,8		5,53	7,5		69	3,1			
	65,0	18,1	23,6		6,11	7,5		69	3,7			
65-50-160	30,9	8,6	24,7		3,58	5,5	Y132S <sub>2</sub> -2 7.5KW	58	2,35	135		
	50,5	14,0	22,4		4,53	5,5		68	3,1			
	60,5	16,8	20,5		5,00	7,5		68	3,7			
65-50-160	28,6	8,0	21,1		2,86	4	Y132S <sub>1</sub> -2 5.5KW	58	2,35	125		
	46,8	13,0	19,2		3,62	5,5		68	3,1			
	56,0	15,6	17,6		4,00	5,5		67	3,7			
65-50-200	36,0	10,0	62,0	2900	10,48	15	Y160L-2 18.5KW	58	2,5	214		
	60,0	16,7	56,0		13,07	15		70	3,2			
	72,0	20,0	50,0		14,41	18,5		68	4			
65-50-200	34,5	9,6	56,0		9,23	11	Y160M <sub>2</sub> -15KW	57	2,5	205		
	57,5	16,0	50,6		11,48	15		69	3,1			
	69,0	19,2	45,0		12,62	15		67	3,75			
65-50-200	33,0	9,1	50,6		8,19	11	Y160M <sub>2</sub> -15KW	56	2,5	195		
	54,5	15,1	45,6		10,02	15		68	3			
	65,5	18,2	40,5		10,94	15		66	3,5			
65-50-200	31,3	8,7	45,5		7,06	7,5	Y160M <sub>1</sub> -11KW	55	2,5	185		
	51,7	14,4	41,0		8,62	11		67	3			
	62,1	17,3	36,5		9,41	11		66	3,5			
65-50-200	29,7	8,3	38,5		5,71	7,5	Y160M <sub>1</sub> -11KW	55	2,5	175		
	49,1	13,6	34,7		7,07	7,5		66	3			
	59,0	16,4	30,8		7,60	11		65	3,5			
65-50-200	28,0	7,8	34,2		4,83	5,5	Y132S <sub>2</sub> -2 7.5KW	54	2,5	165		
	46,3	12,8	30,8		5,97	7,5		65	3			
	55,6	15,4	27,4		6,42	7,5		65	3,5			
65-50-260H	40,0	11,1	100,0		2900	20,16	30	Y200L <sub>2</sub> -2 37KW	54	2,5	264	
	65,0	18,1	91,0			25,97	30		62	3,5		
	78,0	21,7	82,0			29,02	37		60	4,2		
65-50-260H	38,5	10,7	92,5	18,29		22	Y200L <sub>1</sub> -2 30KW	53	2,4	255		
	63,0	17,5	84,0	23,62		30		61	3,3			
	75,5	21,0	75,6	26,34		30		59	3,9			
65-50-260H	37,0	10,3	85,5	16,56		18,5	Y200L <sub>1</sub> -2 30KW	52	2,3	245		
	60,5	16,8	77,5	21,27		30		60	3,2			
	72,5	20,1	69,8	23,75		30		58	3,9			



Модель	Расход		Напор	Скорость	Мощность		модель двигателя	КПД	NPS HR	Рабочее колесо	Диаметр фланца	
					На валу	Двиг.					Вход	Выход
	м <sup>3</sup> /ч	л/с	М	Об/мин	кВт	кВт	%	м	мм	мм	мм	
65-50-260H	35,5	9,9	78,7	2900	14,90	18,5	Y200L <sub>1</sub> -2	51	2,3	235	65	50
	58,0	16,1	71,3		19,09	22	30KW	59	3,2			
	69,5	19,3	64,2		21,33	30		57	3,9			
65-50-260H	34,0	9,4	72,1		13,33	15	Y180M-2	50	2,3	225		
	55,6	15,4	65,3		17,03	22	22KW	58	3,2			
	66,6	18,5	58,8		19,04	22		56	3,9			
65-50-260H	32,5	9,0	65,8		11,75	15	Y160L-2	50	2,3	215		
	53,1	14,7	59,6		14,99	18,5	18.5KW	58	3,2			
	63,6	17,7	53,7		16,76	18,5		56	3,9			
65-50-320H	48,0	13,3	144,0	40,46	45	Y280S-2	47	2,5	329			
	80,0	22,2	133,0	50,81	55	75KW	57	3,7				
	96,0	26,7	124,0	55,87	75		58	3,1				
65-50-320H	46,0	12,8	131,0	36,05	45	Y250M-2	46	2,5	315			
	76,5	21,3	120,0	44,63	55	55KW	56	3,7				
	92,0	25,6	112,0	49,21	55		57	3,3				
65-50-320H	43,5	12,1	118,0	31,40	37	Y250M-2	45	2,4	300			
	73,0	20,3	109,0	39,38	45	55KW	55	3,6				
	87,5	24,3	103,0	43,81	55		56	3,5				
65-50-320H	41,4	11,5	107,0	27,41	30	Y225M-2	44	2,3	285			
	69,0	19,2	98,0	34,09	37	45KW	54	3,5				
	82,8	23,0	92,0	37,70	45		55	3,65				
65-50-320H	39,0	10,8	92,0	22,71	30	Y200L <sub>2</sub> -2	43	2,2	270			
	65,5	18,2	86,0	28,93	37	37KW	53	3,3				
	77,4	21,5	80,0	31,21	37		54	3,7				
65-50-320H	37,0	10,3	82,0	19,66	22	Y200L <sub>1</sub> -2	42	2,1	255			
	62,0	17,2	75,0	24,34	30	30KW	52	3,1				
	74,5	20,7	70,0	26,79	30		53	3,6				
80-65-130	60,0	16,7	25,0	6,09	7,5	Y160M <sub>1</sub> -	67	3	139			
	100,0	27,8	22,0	7,68	11	11KW	78	3,5				
	120,0	33,3	19,0	8,39	11		74	4,5				
80-65-130	56,0	15,6	21,5	5,04	7,5	Y160M <sub>1</sub> -	65	3	130			
	93,5	26,0	18,5	6,20	11	11KW	76	3,5				
	112,5	31,3	16,0	6,81	11		72	4,1				
80-65-130	52,0	14,4	18,0	4,04	5,5	Y132S <sub>2</sub> -2	63	3	120			
	86,5	24,0	15,5	4,93	7,5	7.5KW	74	3,3				
	104,0	28,9	13,0	5,26	7,5		70	3,75				
80-65-160	60,0	16,7	39,0	10,27	15	Y160L-2	62	3,6	174			
	100,0	27,8	35,0	12,70	15	18.5KW	75	4,2				
	120,0	33,3	32,0	13,94	18,5		75	5,2				
80-65-160	57,0	15,8	34,5	8,92	11	Y160M <sub>2</sub> -	60	3,6	165			
	95,0	26,4	31,0	10,98	15	15KW	73	4,1				
	114,0	31,7	28,0	11,90	15		73	4,8				



Модель	Расход		Напор	Скорость	Мощность		модель двигателя	КПД	NPS HR	Рабочее колесо	Диаметр фланца	
					На валу	Двиг.					Вход	Выход
	м3/ч	л/с	М	Об/мин	кВт	кВт	%	м	мм	мм	мм	
80-65-160	53,5	14,9	30,0	2900	7,53	11	Y160M <sub>1</sub> -	58	3,6	155	80	65
	89,0	24,7	27,0		9,21	11	11KW	71	3,95			
	107,0	29,7	24,5		10,05	11		71	4,5			
80-65-160	50,0	13,9	26,3		6,28	11	Y160M <sub>1</sub> -	57	3,6	145		
	83,3	23,1	23,6		7,65	11	11KW	70	3,95			
	100,1	27,8	21,4		8,35	11		70	4,5			
80-65-160	46,6	12,9	22,8		5,15	7,5	Y160M <sub>1</sub> -	56	3,6	135		
	77,5	21,5	20,5		6,26	11	11KW	69	3,95			
	93,2	25,9	18,6		6,83	11		69	4,5			
80-65-160	43,1	12,0	19,5		4,13	5,5	Y132S <sub>2</sub> -2	56	3,6	125		
	71,8	19,9	17,6		5,01	7,5	7.5KW	69	3,95			
	86,3	24,0	15,9		5,46	7,5		69	4,5			
80-65-200H	66,0	18,3	63,0		17,97	22	Y200L <sub>1</sub> -2	63	3	214		
	110,0	30,6	57,0		23,07	30	30KW	74	3,9			
	132,0	36,7	52,0		25,08	30		75	5,3			
80-65-200H	63,0	17,5	57,0	15,77	18,5	Y200L <sub>1</sub> -2	62	3	205			
	105,5	29,3	51,0	20,06	30	30KW	73	3,75				
	126,5	35,1	47,0	22,02	30		74	4,85				
80-65-200H	60,0	16,7	51,5	13,79	18,5	Y200L <sub>1</sub> -2	61	3	195			
	100,0	27,8	46,5	17,58	22	30KW	72	3,6				
	120,0	33,3	42,5	19,15	30		73	4,4				
80-65-200H	56,9	15,8	46,4	11,97	15	Y180M-2	60	3	185			
	94,9	26,4	41,9	15,22	22	22KW	71	3,6				
	113,8	31,6	38,3	16,58	22		72	4,4				
80-65-200H	53,8	15,0	41,5	10,30	15	Y160L-2	59	3	175			
	89,7	24,9	37,4	13,07	18,5	18.5KW	70	3,6				
	107,7	29,9	34,2	14,23	18,5		71	4,4				
80-65-200H	50,8	14,1	36,9	8,71	11	Y160M <sub>2</sub> -	59	3	165			
	84,6	23,5	33,3	11,03	15	15KW	70	3,6				
	101,5	28,2	30,4	12,01	15		70	4,4				
80-65-260	72,0	20,0	97,0	32,78	37	Y250M-2	58	3,3	264			
	120,0	33,3	89,0	39,83	45	55KW	73	4,5				
	144,0	40,0	83,0	44,57	55		73	5,4				
80-65-260	69,5	19,3	90,0	26,20	37	Y225M-2	65	3,25	255			
	116,0	32,2	82,5	36,18	45	45KW	72	4,4				
	139,0	38,6	77,0	40,47	45		72	4,95				
80-65-260	67,0	18,6	83,0	23,65	30	Y225M-2	64	3,2	245			
	111,5	31,0	76,0	32,49	37	45KW	71	4,25				
	133,5	37,1	71,0	36,60	45		71	4,95				
80-65-260	64,3	17,9	76,4	21,20	30	Y200L <sub>2</sub> -2	63	3,2	235			
	106,9	29,7	69,9	29,08	37	37KW	70	4,25				
	128,1	35,6	65,3	33,00	37		69	4,95				





Модель	Расход		Напор	Скорость	Мощность		модель двигателя	КПД	NPS HR	Рабочее колесо	Диаметр фланца		
					На валу	Двиг.					Вход	Выход	
	м3/ч	Л/с	М	Об/мин	кВт	кВт	%	м	мм	мм	мм		
80-65-260	61,5	17,1	70,0	2900	18,91	22	Y200L <sub>2</sub> -2	62	3,2	225	80	65	
	102,4	28,4	64,1		25,89	30	37KW	69	4,25				
	122,6	34,1	59,9		29,39	37		68	4,95				
80-65-260	58,8	16,3	63,9		16,63	18,5	Y200L <sub>1</sub> -2	62	3,2	215			
	97,8	27,2	58,5		22,76	30	30KW	69	4,25				
	117,2	32,5	54,7		25,83	30		68	4,95				
80-65-320H	78,0	21,7	147,0		2900	57,80	75	Y280M-2	54	2,2			329
	130,0	36,1	132,0			74,74	90	90KW	63	2,4			
	156,0	43,3	115,0			81,39	90		60	3,2			
80-65-320H	74,5	20,7	132,0	50,04		55	Y280M-2	54	2,2	315			
	124,0	34,4	118,0	65,30		75	90KW	61	2,3				
	149,0	41,4	102,0	71,33		90		58	3				
80-65-320H	71,0	19,7	118,0	43,03		55	Y280S-2	53	2,2	300			
	119,0	33,0	102,0	56,00		75	75KW	59	2,2				
	142,0	39,4	88,0	61,29		75		56	2,7				
80-65-320H	67,5	18,8	105,0	37,10		45	Y280S-2	52	2,2	285			
	113,0	31,4	93,0	48,90		55	75KW	59	2,2				
	135,0	37,5	79,0	53,27		75		55	2,5				
80-65-320H	64,0	17,8	94,0	32,11		37	Y250M-2	51	2,2	270			
	107,0	29,7	82,0	41,18		55	55KW	58	2,2				
	128,0	35,6	70,0	45,59		55		54	2,4				
80-65-320H	60,0	16,7	82,0	26,79		30	Y225M-2	50	2,15	255			
	100,0	27,8	72,0	34,39		37	45KW	57	2,2				
	120,0	33,3	61,0	38,32		45		52	2,3				
100-80-160	100,0	27,8	39,0	2900		15,85	18,5	Y200L <sub>1</sub> -2	67	3,3	174		
	162,0	45,0	35,0			19,29	22	30KW	80	4			
	195,0	54,2	31,5			21,17	30		79	5			
100-80-160	95,0	26,4	34,5			13,73	18,5	Y180M-2	65	3,3	165		
	153,5	42,6	31,0			16,61	18,5	22KW	78	3,85			
	185,0	51,4	28,0			18,31	22		77	4,6			
100-80-160	89,0	24,7	30,5		11,73	15	Y160L-2	63	3,25	155			
	144,5	40,1	27,2		14,08	15	18.5KW	76	3,7				
	174,0	48,3	24,5		15,47	18,5		75	4,3				
100-80-160	83,3	23,1	26,7		9,76	11	Y160M <sub>2</sub> -	62	3,25	145			
	135,2	37,5	23,8		11,68	15	15KW	75	3,7				
	162,8	45,2	21,4		12,84	15		74	4,3				
100-80-160	77,5	21,5	23,1		7,94	11	Y160M <sub>2</sub> -	62	3,25	135			
	125,9	35,0	20,6		9,49	15	15KW	75	3,7				
	151,5	42,1	18,6		10,43	15		74	4,3				
100-80-200	115,0	31,9	61,0		2900	27,28	37	Y225M-2	70	4	214		
	190,0	52,8	55,0			35,56	37	45KW	80	5,1			
	225,0	62,5	50,0			38,77	45		79	6,2			



Модель	Расход		Напор	Скорость	Мощность		модель двигателя	КПД	NPS HR	Рабочее колесо	Диаметр фланца	
					На валу	Двиг.					Вход	Выход
	м3/ч	Л/с	М	Об/мин	кВт	кВт	%	м	мм	мм	мм	
100-80-200	110,0	30,6	55,5	2900	24,09	30	Y200L <sub>2</sub> -2	69	4	205	100	80
	182,0	50,6	50,0		31,36	37	37KW	79	4,9			
	215,5	59,9	45,5		34,22	37		78	5,85			
100-80-200	105,0	29,2	50,0		21,02	30	Y200L <sub>2</sub> -2	68	4	195		
	173,0	48,1	45,0		27,17	30	37KW	78	4,7			
	205,0	56,9	41,0		29,71	37		77	5,5			
100-80-200	99,6	27,7	45,0		18,21	22	Y200L <sub>1</sub> -2	67	4	185		
	164,1	45,6	40,5		23,50	30	30KW	77	4,7			
	194,5	54,0	36,9		25,71	30		76	5,5			
100-80-200	94,2	26,2	40,3		15,65	18,5	Y200L <sub>1</sub> -2	66	4	175		
	155,3	43,1	36,2		20,15	30	30KW	76	4,7			
	184,0	51,1	33,0		22,05	30		75	5,5			
100-80-200	88,8	24,7	35,8		13,22	15	Y180M-2	66	4	165		
	146,4	40,7	32,2		17,00	22	22KW	76	4,7			
	173,5	48,2	29,4		18,60	22		75	5,5			
100-80-260	115,0	31,9	96,0	45,54	55	Y280S-2	66	4	264			
	190,0	52,8	86,0	57,77	75	75KW	77	5,4				
	225,0	62,5	79,0	64,52	75		75	6,5				
100-80-260	111,0	30,8	89,0	41,37	55	Y280S-2	65	3,95	255			
	183,5	51,0	79,8	52,45	75	75KW	76	5,2				
	217,5	60,4	73,0	58,41	75		74	6,25				
100-80-260	106,5	29,6	82,0	37,15	45	Y280S-2	64	3,9	245			
	176,5	49,0	73,5	47,09	55	75KW	75	5				
	209,0	58,1	67,5	52,61	75		73	6				
100-80-260	102,2	28,4	75,4	33,30	45	Y250M-2	63	3,9	235			
	169,3	47,0	67,6	42,11	55	55KW	74	5				
	200,5	55,7	62,1	47,07	55		72	6				
100-80-260	97,8	27,2	69,2	29,70	37	Y250M-2	62	3,9	225			
	162,1	45,0	62,0	37,47	45	55KW	73	5				
	191,9	53,3	56,9	41,31	55		72	6				
100-80-260	93,5	26,0	63,1	26,12	37	Y225M-2	62	3,9	215			
	154,9	43,0	56,6	32,92	37	45KW	73	5				
	183,4	50,9	52,0	36,30	45		72	6				
100-80-320H	120,0	33,3	142,0	76,04	90	Y315M <sub>1</sub> -	61	3,1	329			
	200,0	55,6	127,0	101,68	132	132KW	68	3,4				
	240,0	66,7	110,0	112,29	132		64	3,7				
100-80-320H	115,0	32,0	130,0	67,83	75	Y315S-2	60	3,05	315			
	191,0	53,0	116,0	90,02	110	110KW	67	3,3				
	230,0	63,9	100,0	99,38	110		63	3,6				
100-80-320H	110,0	30,6	118,0	59,89	75	Y315S-2	59	3,05	300			
	182,0	50,6	103,0	77,91	90	110KW	66	3,2				
	220,0	61,1	89,0	86,67	110		62	3,5				



Модель	Расход		Напор	Скорость	Мощность		модель двигателя	КПД	NPS HR	Рабочее колесо	Диаметр фланца				
					На валу	Двиг.					Вход	Выход			
	м3/ч	Л/с	М	Об/мин	кВт	кВт	%	м	мм	мм	мм				
100-80-320H	104,0	28,9	106,0	2900	51,74	75	Y280M-2	58	2,95	285	100	80			
	173,0	48,0	92,0		67,17	75	90KW	65	3,2						
	208,0	57,8	79,0		74,55	90		60	3,4						
100-80-320H	98,5	27,4	94,0		44,22	55	Y280S-2	57	2,9	270					
	164,0	45,6	82,0		57,65	75	75KW	64	3,15						
	197,0	54,7	70,0		64,72	75		58	3,3						
100-80-320H	93,0	25,8	84,0		37,98	45	Y280S-2	56	2,9	255					
	155,0	43,1	70,0		47,64	55	75KW	62	3,1						
	186,0	51,7	60,0		54,25	75		56	3,2						
125-100-160	165,0	45,8	37,5		2900	24,06	30	Y200L <sub>1</sub> -2	70	5			190	125	100
	200,0	55,6	34,0			25,71	30	30KW	72	5					
	270,0	75,0	22,5			27,56	30		60	5,5					
125-100-160	156,3	43,4	33,7	20,62		22	Y200L <sub>1</sub> -2	70	4,9	180					
	189,5	52,6	30,5	22,03		30	30KW	72	4,9						
	255,8	71,1	20,2	23,65		30		60	5,4						
125-100-160	139,9	38,9	27,0	14,88		18,5	Y180M-2	69	4,8	170					
	169,5	47,1	24,4	15,89		18,5	22KW	71	4,8						
	228,9	63,6	16,2	17,08		22		59	5,3						
125-100-160	117,8	32,7	19,1	8,95		15	Y160L-2	69	4,7	160					
	142,8	39,7	17,3	9,55		15	18.5KW	71	4,7						
	192,7	53,5	11,5	10,29		18,5		59	5,2						
125-100-200	180,0	50,0	59,0	2900	41,30	55	Y280S-2	70	4	214	125	100			
	285,0	79,2	52,0		50,12	75	75KW	81	5,3						
	340,0	94,4	44,0		54,66	75		75	6,3						
125-100-200	172,5	47,9	52,5		35,73	45	Y250M-2	69	3,95	205					
	273,0	75,8	46,0		43,00	55	55KW	80	4,9						
	325,5	90,4	38,0		45,81	55		74	5,95						
125-100-200	164,0	45,6	47,0		30,86	37	Y225M-2	68	3,9	195					
	260,0	72,2	40,0		36,07	45	45KW	79	4,8						
	310,0	86,1	32,5		37,83	45		73	5,6						
125-100-200	155,6	43,2	42,3		26,74	37	Y200L <sub>2</sub> -2	67	3,9	185					
	246,7	68,5	36,0		31,39	37	37KW	77	4,8						
	294,1	81,7	29,3		32,75	37		72	5,6						
125-100-200	147,2	40,9	37,9	22,98	30	Y200L <sub>1</sub> -2	66	3,9	175						
	233,3	64,8	32,2	26,92	30	30KW	76	4,8							
	278,2	77,3	26,2	28,12	30		71	5,6							
125-100-200	138,8	38,5	33,6	19,41	30	Y200L <sub>1</sub> -2	66	3,9	165						
	220,0	61,1	28,6	22,72	30	30KW	76	4,8							
	262,3	72,9	23,3	23,73	30		70	5,6							
125-100-260	190,0	52,8	97,0	2900	71,67	90	Y315S-2	70	3,8	264	125	100			
	295,0	81,9	85,0		87,51	100	110KW	78	5,2						
	350,0	97,2	75,0		97,89	110		73	6,5						



Модель	Расход		Напор	Скорость	Мощность		модель двигателя	КПД	NPS HR	Рабочее колесо	Диаметр фланца	
					На валу	Двиг.					Вход	Выход
	м3/ч	Л/с	М	Об/мин	кВт	кВт	%	м	мм	мм	мм	
125-100-260	183,5	51,0	89,0	2900	64,43	75	Y315S-2	69	3,75	255	125	100
	285,0	79,2	78,0		78,59	90	110KW	77	5			
	338,0	93,9	68,5		87,54	100		72	6,2			
125-100-260	177,0	49,2	82,0	2900	58,10	75	Y280M-2	68	3,7	245	125	100
	274,0	76,1	71,5		70,17	90	90KW	76	4,8			
	325,0	90,3	63,0		78,50	90		71	5,9			
125-100-260	169,8	47,2	75,4	2900	52,04	75	Y280S-2	67	3,7	235	125	100
	262,8	73,0	65,8		62,75	75	75KW	75	4,8			
	311,7	86,6	58,0		70,27	75		70	5,9			
125-100-260	162,6	45,2	69,2	2900	46,37	55	Y280S-2	66	3,7	225	125	100
	251,6	69,9	60,3		55,82	75	75KW	74	4,8			
	298,5	82,9	53,1		62,56	75		69	5,9			
125-100-260	155,3	43,1	63,1	2900	40,76	55	Y280S-2	66	3,7	215	125	100
	240,4	66,8	55,1		49,03	75	75KW	74	4,8			
	285,2	79,2	48,5		54,99	75		69	5,9			
150-125-200	238,0	66,0	54,5	2900	59,34	75	Y280M-2	60	7	214	150	125
	360,0	100,0	49,0		66,23	90	90KW	73	7,2			
	475,0	132,0	40,0		70,85	90		73	7			
150-125-200	228,0	63,2	49,5	2900	52,52	75	Y280S-2	59	7	205	150	125
	345,0	95,8	44,0		57,79	75	75KW	72	7,1			
	455,0	126,0	35,3		60,73	75		72	6,85			
150-125-200	216,0	60,1	44,8	2900	45,81	55	Y280S-2	58	7	195	150	125
	328,0	91,1	39,5		50,03	55	75KW	71	6,95			
	433,0	120,0	31,5		52,30	75		71	6,6			
150-125-200	205,3	57,0	40,3	2900	40,23	55	Y225M-2	56	7	185	150	125
	311,1	86,4	35,6		43,02	55	45KW	70	6,5			
	409,8	113,8	28,4		44,87	55		71	6,4			



4-х полюсные, 50Гц, 1450 об/мин

Модель	Расход		Напор	Скорость	Power		модель двигателя	КПД	NPS HR	Рабочее колесо	Диаметр фланца	
					На валу	Двиг.					Вход	Выход
	м3/ч	Л/с	М	Об/мин	кВт	кВт	%	м	мм	мм	мм	
50-32-130	4,5	1,3	6,0	1450	0,16	0,55	Y801-4	47	1,8	139	50	32
	7,5	2,1	5,5		0,20	0,55	0.55KW	57	2			
	9,0	2,5	5,0		0,21	0,55		58	2,3			
50-32-130	4,2	1,2	5,2		0,13	0,55	Y801-4	47	1,8	130		
	7,0	1,9	4,8		0,16	0,55	0.55KW	57	2			
	8,4	2,3	4,4		0,17	0,55		58	2,3			
50-32-130	3,9	1,1	4,5		0,10	0,55	Y801-4	46	1,8	120		
	6,5	1,8	4,1		0,13	0,55	0.55KW	56	2			
	7,8	2,2	3,7		0,14	0,55		57	2,3			
50-32-130	3,6	1,0	3,8		0,08	0,55	Y801-4	46	1,8	110		
	5,9	1,6	3,4		0,10	0,55	0.55KW	56	2			
	7,1	2,0	3,1		0,11	0,55		57	2,3			
50-32-130	3,2	0,9	3,1		0,06	0,55	Y801-4	45	1,8	100		
	5,4	1,5	2,8		0,08	0,55	0.55KW	55	2			
	6,5	1,8	2,6		0,08	0,55		56	2,3			
50-32-160	6,0	1,7	9,5	0,35	0,55	Y801-4	44	1,8	174			
	9,0	2,5	9,0	0,42	0,55	0.55KW	53	2				
	11,0	3,1	8,3	0,46	0,55		54	2,4				
50-32-160	5,7	1,6	8,5	0,30	0,55	Y801-4	44	1,8	165			
	8,5	2,4	8,1	0,36	0,55	0.55KW	53	2				
	10,4	2,9	7,5	0,40	0,55		54	2,4				
50-32-160	5,4	1,5	7,5	0,26	0,55	Y801-4	43	1,8	155			
	8,0	2,2	7,1	0,30	0,55	0.55KW	52	2				
	9,8	2,7	6,6	0,33	0,55		53	2,4				
50-32-160	5,0	1,4	6,6	0,21	0,55	Y801-4	43	1,8	145			
	7,5	2,1	6,3	0,25	0,55	0.55KW	52	2				
	9,2	2,5	5,8	0,27	0,55		53	2,4				
50-32-160	4,7	1,3	5,7	0,17	0,55	Y801-4	42	1,8	135			
	7,0	1,9	5,4	0,20	0,55	0.55KW	51	2				
	8,5	2,4	5,0	0,22	0,55		52	2,4				
50-32-160	4,3	1,2	4,9	0,14	0,55	Y801-4	42	1,8	125			
	6,5	1,8	4,6	0,16	0,55	0.55KW	51	2				
	7,9	2,2	4,3	0,18	0,55		52	2,4				
50-32-200	6,0	1,7	15,0	0,64	0,75	Y90S-4	38	1,8	214			
	9,0	14,0	14,0	0,76	1,1	1.1KW	45	2				
	11,0	13,2	13,2	0,84	1,1		47	2,3				
50-32-200	5,7	1,6	13,8	0,58	0,75	Y90S-4	37	1,8	205			
	8,6	2,4	12,9	0,69	1,1	1.1KW	44	2				
	10,5	2,9	12,1	0,76	1,1		46	2,3				
50-32-200	5,5	1,5	12,5	0,51	0,75	Y2-802-4	37	1,8	195			
	8,2	2,3	11,6	0,60	0,75	0.75KW	44	2				
	10,0	2,8	11,0	0,66	0,75		46	2,3				



Модель	Расход		Напор	Скорос ть	Power		модель двигателя	КПД	NPS HR	Рабочее колесо	Диаметр фланца		
					На валу	Двиг.					Вход	Выход	
	м3/ч	Л/с	М	Об/мин	кВт	кВт	%	м	мм	мм			мм
50-32-200	5,2	1,4	11,2	1450	0,44	0,75	Y2-802-4	36	1,8	185	50	32	
	7,8	2,2	10,5		0,52	0,75	0.75KW	43	2				
	9,5	2,6	9,9		0,57	0,75		45	2,3				
50-32-200	4,9	1,4	10,0		0,38	0,55	Y2-801-4	36	1,8	175			
	7,4	2,0	9,4		0,44	0,55	0.55KW	43	2				
	9,0	2,5	8,8		0,49	0,55		45	2,3				
50-32-200	4,6	1,3	8,9		0,32	0,55	Y2-801-4	35	1,8	165			
	6,9	1,9	8,3		0,37	0,55	0.55KW	42	2				
	8,5	2,4	7,9		0,41	0,55		44	2,3				
50-32-260	7,0	1,9	24,2		1450	1,54	2,2	Y100L <sub>2</sub> -4	30	1,8			264
	11,0	3,1	23,0			1,81	2,2	3KW	38	2			
	13,0	3,6	22,0			1,95	3		40	2,4			
50-32-260	6,8	1,9	22,6	1,43		2,2	Y100L <sub>1</sub> -4	29	1,8	255			
	10,6	3,0	21,5	1,68		2,2	2.2KW	37	2				
	12,6	3,5	20,5	1,80		2,2		39	2,4				
50-32-260	6,5	1,8	20,8	1,32		2,2	Y100L <sub>1</sub> -4	28	1,8	245			
	10,2	2,8	19,8	1,53		2,2	2.2KW	36	2				
	12,1	3,4	18,9	1,64		2,2		38	2,4				
50-32-260	6,2	1,7	19,2	1,19		2,2	Y100L <sub>1</sub> -4	28	1,8	235			
	9,8	2,7	18,3	1,37		2,2	2.2KW	36	2				
	11,6	3,2	17,5	1,47		2,2		38	2,4				
50-32-260	6,0	1,7	17,8	1,07		1,5	Y90L-4	27	1,8	225			
	9,4	2,6	16,9	1,24		1,5	1.5KW	35	2				
	11,1	3,1	16,1	1,32		1,5		37	2,4				
50-32-260	5,7	1,6	16,2	0,95		1,5	Y90L-4	27	1,8	215			
	9,0	2,5	15,4	1,09		1,5	1.5KW	35	2				
	10,6	3,0	14,7	1,17		1,5		37	2,4				
65-40-130	9,0	2,5	6,3	1450		0,30	0,55	Y801-4	52	1,8	139		
	15,0	4,2	5,8			0,36	0,55	0.55KW	65	2			
	18,0	5,0	5,3			0,41	0,55		64	2,4			
65-40-130	8,4	2,3	5,5			0,25	0,55	Y801-4	52	1,8	130		
	14,0	3,9	5,1			0,30	0,55	0.55KW	65	2			
	16,8	4,7	4,6			0,33	0,55		64	2,4			
65-40-130	7,9	2,2	4,7		0,20	0,55	Y801-4	51	1,8	120			
	13,1	3,6	4,3		0,24	0,55	0.55KW	64	2				
	15,7	4,4	4,0		0,27	0,55		63	2,4				
65-40-130	7,4	2,0	3,9		0,16	0,55	Y801-4	51	1,8	110			
	12,3	3,4	3,6		0,19	0,55	0.55KW	64	2				
	14,7	4,1	3,3		0,21	0,55		63	2,4				
65-40-130	6,9	1,9	3,3		0,12	0,55	Y801-4	50	1,8	100			
	11,5	3,2	3,0		0,15	0,55	0.55KW	63	2				
	13,8	3,8	2,7		0,17	0,55		62	2,4				



Модель	Расход		Напор	Скорос ть	Power		модель двигателя	КПД	NPS HR	Рабочее колесо	Диаметр фланца	
					На валу	Двиг.					Вход	Выход
	м3/ч	Л/с	М	Об/мин	кВт	кВт	%	м	мм	мм		
65-40-160	9,0	2,5	9,7	1450	0,50	0,55	Y90S-4	48	1,8	174	65	40
	15,0	4,2	8,5		0,58	0,75	1.1KW	60	2			
	18,0	5,0	7,6		0,64	1,1		58	2,4			
65-40-160	8,5	30,7	8,7		0,43	0,75	Y2-802-4	48	1,8	165		
	14,2	51,2	7,6		0,50	0,75	0.75KW	60	2			
	17,1	61,4	6,8		0,55	0,75		58	2,4			
65-40-160	8,0	28,9	7,7		0,36	0,75	Y2-802-4	47	1,8	155		
	13,4	48,1	6,7		0,42	0,75	0.75KW	59	2			
	16,0	57,7	6,0		0,46	0,75		57	2,4			
65-40-160	7,5	27,0	6,7		0,30	0,55	Y801-4	47	1,8	145		
	12,5	45,0	5,9		0,34	0,55	0.55KW	59	2			
	15,0	54,0	5,3		0,38	0,55		57	2,4			
65-40-160	7,0	25,1	5,8		0,24	0,55	Y801-4	46	1,8	135		
	11,6	41,9	5,1		0,28	0,55	0.55KW	58	2			
	14,0	50,3	4,6		0,31	0,55		56	2,4			
65-40-160	6,5	23,3	5,0		0,19	0,55	Y801-4	46	1,8	125		
	10,8	38,8	4,4		0,22	0,55	0.55KW	58	2			
	12,9	46,6	3,9		0,25	0,55		56	2,4			
65-40-200	9,0	2,5	15,2		0,79	1,1	Y90L-4	47	1,8	214		
	15,0	4,2	14,0		1,04	1,5	1.5KW	55	2			
	18,0	5,0	12,8		1,16	1,5		54	2,4			
65-40-200	8,6	2,4	13,9	0,71	1,1	Y90L-4	46	1,8	205			
	14,4	4,0	12,8	0,93	1,1	1.5KW	54	2				
	17,2	4,8	11,7	1,04	1,5		53	2,4				
65-40-200	8,2	2,3	12,6	0,62	1,1	Y90S-4	45	1,8	195			
	13,7	3,8	11,6	0,81	1,1	1.1KW	53	2				
	16,4	4,6	10,6	0,91	1,1		52	2,4				
65-40-200	7,8	2,2	11,3	0,46	1,1	Y90S-4	53	1,8	185			
	13,0	3,6	10,4	0,83	1,1	1.1KW	45	2				
	15,6	4,3	9,5	0,77	1,1		53	2,4				
65-40-200	7,4	2,1	10,1	0,40	1,1	Y90S-4	52	1,8	175			
	12,4	3,4	9,3	0,60	1,1	1.1KW	52	2				
	14,8	4,1	8,5	0,78	1,1		44	2,4				
65-40-200	7,0	1,9	9,0	0,34	1,1	Y90S-4	51	1,8	165			
	11,7	3,2	8,3	0,51	1,1	1.1KW	52	2				
	14,0	3,9	7,6	0,66	1,1		44	2,4				
65-40-260	10,0	2,8	24,0	1,77	2,2	Y100L <sub>2</sub> -4	37	1,8	264			
	16,0	4,4	23,0	2,18	2,2	3KW	46	2				
	20,0	5,6	21,8	2,37	3		50	2,4				
65-40-260	9,7	2,7	22,4	1,64	2,2	Y100L <sub>2</sub> -4	36	1,8	255			
	15,5	4,3	21,5	2,01	3	3KW	45	2				
	19,3	5,4	20,3	2,18	3		49	2,4				



Модель	Расход		Напор М	Скорос ть Об/мин	Power		модель двигателя	КПД %	NPS HR м	Рабочее колесо мм	Диаметр фланца	
					На валу кВт	Двиг. кВт					Вход мм	Выход мм
	м3/ч	Л/с			кВт	кВт						
65-40-260	9,3	2,6	20,7	1450	1,49	2,2	Y100L <sub>2</sub> -4	35	1,8	245	65	40
	14,8	4,1	19,8		1,82	2,2	3KW	44	2			
	18,6	5,2	18,8		1,98	3		48	2,4			
65-40-260	8,9	2,5	19,0		1,36	2,2	Y100L <sub>1</sub> -4	34	1,8	235		
	14,2	4,0	18,2		1,64	2,2	2.2KW	43	2			
	17,8	4,9	17,3		1,78	2,2		47	2,4			
65-40-260	8,5	2,4	17,4		1,23	1,5	Y100L <sub>1</sub> -4	33	1,8	225		
	13,6	3,8	16,7		1,48	2,2	2.2KW	42	2			
	17,0	4,7	15,8		1,60	2,2		46	2,4			
65-40-260	8,1	2,3	15,9		1,09	1,5	Y100L <sub>1</sub> -4	33		215		
	13,0	3,6	15,3		1,30	2,2	2.2KW	42				
	16,3	4,5	14,5		1,41	2,2		46				
65-40-320	11,0	3,0	38,0		3,56	5,5	Y132S-4	32	3,1	329		
	18,0	5,0	35,0		4,23	5,5	5.5KW	41	2,1			
	21,5	6,0	32,0		4,80			39	3,8			
65-40-320	10,5	2,9	34,5	3,23	4	Y132S-4	31	3,3	315			
	17,0	4,7	32,0	3,85	5,5	5.5KW	39	2				
	20,5	5,7	29,0	4,32	5,5		38	2,9				
65-40-320	10,0	2,8	31,0	2,91	4	Y132S-4	29	3,6	300			
	16,5	4,6	29,0	3,52	5,5	5.5KW	37	2				
	20,0	5,6	26,0	3,93	5,5		36	2,7				
65-40-320	9,5	2,6	28,0	2,58	4	Y112 M-4	28	3,6	285			
	15,7	4,4	26,2	3,10	4	4KW	36	2				
	19,0	5,3	23,5	3,47	4		35	2,7				
65-40-320	9,0	2,5	26,0	2,45	3	Y112 M-4	26	3,6	270			
	14,9	4,1	24,4	2,81	4	4KW	35	2				
	18,0	5,0	21,8	3,15	4		34	2,7				
65-40-320	8,5	2,4	24,2	2,19	3	Y112 M-4	26	3,6	255			
	14,0	3,9	22,6	2,50	4	4KW	35	2				
	17,0	4,7	20,3	2,80	4		34	2,7				
65-50-130	18,0	5,0	6,4	0,51	0,75	Y90S-4	61	2,2	139			
	30,0	8,3	5,8	0,66	0,75	1.1KW	72	2,4				
	36,0	10,0	5,2	0,74	1,1		69	2,8				
65-50-130	16,8	4,7	5,6	0,42	0,75	Y90S-4	61	2,2	130			
	28,1	7,8	5,1	0,54	0,75	1.1KW	72	2,4				
	33,7	9,4	4,5	0,61	1,1		69	2,8				
65-50-130	15,5	4,3	4,8	0,34	0,75	Y2-802-4	60	2,2	120			
	25,9	7,2	4,3	0,43	0,75	0.75KW	71	2,4				
	31,1	8,6	3,9	0,48	0,75		68	2,8				
65-50-130	14,2	4,0	4,0	0,26	0,55	Y801-4	60	2,2	110			
	23,7	6,6	3,6	0,33	0,55	0.55KW	71	2,4				
	28,5	7,9	3,3	0,37	0,55		68	2,8				





Модель	Расход		Напор	Скорос ть	Power		модель двигателя	КПД	NPS HR	Рабочее колесо	Диаметр фланца	
					На валу	Двиг.					Вход	Выход
	м3/ч	Л/с	М	Об/мин	кВт	кВт	%	м	мм	мм	мм	
65-50-160	20,0	5,6	10,3	1450	0,93	1,1	Y90L-4	60	2,3	174	65	50
	32,0	8,9	9,5		1,18	1,5	1.5KW	70	2,4			
	38,0	10,6	8,8		1,30	1,5		70	3			
65-50-160	19,0	5,3	9,3		0,80	1,1	Y90L-4	60	2,3	165		
	30,3	8,4	8,5		1,02	1,5	1.5KW	70	2,4			
	36,0	10,0	7,9		1,12	1,5		70	3			
65-50-160	17,8	4,9	8,2		0,67	1,1	Y90L-4	59	2,3	155		
	28,5	7,9	7,5		0,85	1,1	1.5KW	69	2,4			
	33,9	9,4	7,0		0,93	1,5		69	3			
65-50-160	16,7	4,6	7,2		0,55	0,75	Y90S-4	59	2,3	145		
	26,7	7,4	6,6		0,70	1,1	1.1KW	69	2,4			
	31,7	8,8	6,1		0,77	1,1		69	3			
65-50-160	15,5	4,3	6,2		0,45	0,75	Y90S-4	58	2,3	135		
	24,8	6,9	5,7		0,57	1,1	1.1KW	68	2,4			
	29,5	8,2	5,3		0,63	1,1		68	3			
65-50-160	14,4	4,0	5,3	0,36	0,75	Y2-802-4	58	2,3	125			
	23,0	6,4	4,9	0,45	0,75	0.75KW	68	2,4				
	27,3	7,6	4,5	0,50	0,75		68	3				
65-50-200	18,0	5,0	15,4	1,37	1,5	Y100L <sub>1</sub> -4	55	2,2	214			
	30,0	8,3	13,5	1,70	2,2	2.2KW	65	2,3				
	36,0	10,0	11,6	1,86	2,2		61	2,9				
65-50-200	17,2	4,8	14,1	1,23	2,2	Y100L <sub>1</sub> -4	54	2,2	205			
	28,7	8,0	12,4	1,51	2,2	2.2KW	64	2,3				
	34,5	9,6	10,6	1,67	2,2		60	2,9				
65-50-200	16,4	4,6	12,8	1,08	1,5	Y100L <sub>1</sub> -4	53	2,2	195			
	27,3	7,6	11,2	1,32	2,2	2.2KW	63	2,3				
	32,8	9,1	9,6	1,46	2,2		59	2,9				
65-50-200	15,6	4,3	11,5	0,93	1,1	Y90L-4	53	2,2	185			
	25,9	7,2	10,1	1,14	1,5	1.5KW	63	2,3				
	31,1	8,6	8,7	1,26	1,5		59	2,9				
65-50-200	14,7	4,1	9,7	0,75	1,1	Y90L-4	52	2,2	175			
	24,5	6,8	8,5	0,92	1,5	1.5KW	62	2,3				
	29,4	8,2	7,3	1,01	1,5		58	2,9				
65-50-200	13,9	3,9	8,6	0,63	1,1	Y90L-4	52	2,2	165			
	23,1	6,4	7,6	0,78	1,5	1.5KW	62	2,3				
	27,8	7,7	6,5	0,86	1,5		58	2,9				
65-50-260	20,0	5,6	25,0	2,62	3	Y132S-4	52	2,3	264			
	32,0	8,9	22,5	3,27	4	5.5KW	60	2,4				
	38,0	10,6	19,8	3,63	5,5		57	3				
65-50-260	19,3	5,4	23,3	2,41	3	Y132S-4	51	2,3	255			
	30,9	8,6	21,0	2,99	4	5.5KW	59	2,4				
	36,7	10,2	18,5	3,33	5,5		56	3				



Модель	Расход		Напор	Скорос ть	Power		модель двигателя	КПД	NPS HR	Рабочее колесо	Диаметр фланца	
					На валу	Двиг.					Вход	Выход
	мЗл	Л/с	М	Об/мин	кВт	кВт	%	м	мм	мм	мм	
65-50-260	18,6	5,2	21,5	1450	2,18	3	Y112 M-4	50	2,3	245	65	50
	29,7	8,2	19,4		2,70	4	4KW	58	2,4			
	35,3	9,8	17,1		3,00	4		55	3			
65-50-260	17,8	4,9	19,8		1,96	3	Y112 M-4	49	2,3	235		
	28,5	7,9	17,8		2,43	3	4KW	57	2,4			
	33,8	9,4	15,7		2,70	4		54	3			
65-50-260	17,0	4,7	18,2		1,76	3	Y100L <sub>2</sub> -4	48	2,3	225		
	27,3	7,6	16,3		2,17	3	3KW	56	2,4			
	32,4	9,0	14,4		2,42	3		53	3			
65-50-260	16,3	4,5	16,6		1,55	3	Y100L <sub>2</sub> -4	48	2,3	215		
	26,1	7,2	14,9		1,91	3	3KW	56	2,4			
	30,9	8,6	13,1		2,13	3		52	3			
65-50-320	24,0	6,7	36,0	5,00	5,5	Y160M-4	47	2	329			
	40,0	11,1	34,0	6,38	7,5	11KW	58	2,5				
	48,0	13,3	32,0	7,09	11		59	3,2				
65-50-320	23,0	6,4	32,5	4,52	5,5	Y132M-4	45	2	315			
	38,5	10,7	30,6	5,73	7,5	7.5KW	56	2,4				
	46,0	12,8	28,7	6,36	7,5		57	3				
65-50-320	22,0	6,1	29,4	4,24	5,5	Y132M-4	42	2	300			
	36,5	10,1	27,7	5,10	7,5	7.5KW	54	2,3				
	44,0	12,2	26,0	5,66	7,5		55	2,8				
65-50-320	20,9	5,8	26,5	3,72	5,5	Y132M-4	41	2	285			
	34,7	9,6	24,9	4,44	7,5	7.5KW	53	2,3				
	41,8	11,6	23,4	4,93	7,5		54	2,8				
65-50-320	19,8	5,5	23,7	3,24	4	Y132S-4	40	2	270			
	32,9	9,1	22,4	3,85	5,5	5.5KW	52	2,3				
	39,6	11,0	21,0	4,27	5,5		53	2,8				
65-50-320	18,8	5,2	21,2	2,77	4	Y132S-4	39	2	255			
	31,1	8,6	20,0	3,28	5,5	5.5KW	52	2,3				
	37,5	10,4	18,7	3,64	5,5		53	2,8				
80-65-130	30,0	8,3	6,2	0,79	1,1	Y90L-4	64	2,2	139			
	50,0	13,9	5,4	0,98	1,1	1.5KW	75	2,4				
	60,0	16,7	4,7	1,05	1,5		73	2,8				
80-65-130	28,1	7,8	5,4	0,65	1,1	Y90S-4	64	2,2	130			
	46,8	13,0	4,7	0,81	1,1	1.1KW	75	2,4				
	56,1	15,6	4,1	0,87	1,1		73	2,8				
80-65-130	25,9	7,2	4,6	0,52	1,1	Y90S-4	63	2,2	120			
	43,2	12,0	4,0	0,64	1,1	1.1KW	74	2,4				
	51,8	14,4	3,5	0,69	1,1		72	2,8				
80-65-160	30,0	8,3	9,8	1,33	2,2	Y100L <sub>1</sub> -4	60	2	174			
	50,0	13,9	8,8	1,62	2,2	2.2KW	74	2,2				
	60,0	16,7	7,9	1,76	2,2		74	2,5				



Модель	Расход		Напор	Скорос ть	Power		модель двигателя	КПД	NPS HR	Рабочее колесо	Диаметр фланца	
					На валу	Двиг.					Вход	Выход
	м3/ч	Л/с	М	Об/мин	кВт	кВт	%	м	мм	мм	мм	
80-65-160	28,4	7,9	8,8	1450	1,15	2,2	Y100L <sub>1</sub> -4	60	2	165	80	65
	47,4	13,2	7,9		1,39	2,2	2.2KW	74	2,2			
	56,9	15,8	7,1		1,51	2,2		73	2,5			
80-65-160	26,7	7,4	7,8		0,96	1,1	Y90L-4	59	2	155		
	44,5	12,4	7,0		1,16	1,1	1.5KW	73	2,2			
	53,4	14,8	6,3		1,26	1,5		73	2,5			
80-65-160	25,0	6,9	6,8		0,79	1,1	Y90L-4	59	2	145		
	41,7	11,6	6,1		0,96	1,5	1.5KW	73	2,2			
	50,0	13,9	5,5		1,04	1,5		72	2,5			
80-65-160	23,3	6,5	5,9		0,64	1,1	Y90S-4	58	2	135		
	38,8	10,8	5,3		0,78	1,1	1.1KW	72	2,2			
	46,6	12,9	4,8		0,84	1,1		72	2,5			
80-65-160	21,6	6,0	5,1		0,52	1,1	Y90S-4	58	2	125		
	35,9	10,0	4,5		0,62	1,1	1.1KW	72	2,2			
	43,1	12,0	4,1		0,67	1,1		71	2,5			
80-65-200	35,0	9,7	15,3	1450	2,31	3	Y112 M-4	63	1,9	214		
	55,0	15,3	14,0		2,87	4	4KW	73	2			
	66,0	18,3	13,1		3,20	4		74	2,3			
80-65-200	33,5	9,3	14,0		2,07	3	Y112 M-4	62	1,9	205		
	52,7	14,6	12,8		2,56	4	4KW	72	2			
	63,2	17,6	12,0		2,85	4		73	2,3			
80-65-200	31,9	8,9	12,7		1,81	2,2	Y100L <sub>2</sub> -4	61	1,9	195		
	50,1	13,9	11,6		2,23	3	3KW	71	2			
	60,1	16,7	10,9		2,49	3		72	2,3			
80-65-200	30,3	8,4	11,4		1,56	2,2	Y100L <sub>1</sub> -4	61	1,9	185		
	47,5	13,2	10,5		1,92	2,2	2.2KW	71	2			
	57,1	15,8	9,8		2,14	2,2		71	2,3			
80-65-200	28,6	8,0	10,2		1,33	1,5	Y100L <sub>1</sub> -4	60	1,9	175		
	45,0	12,5	9,4		1,64	2,2	2.2KW	70	2			
	54,0	15,0	8,8		1,83	2,2		71	2,3			
80-65-200	26,3	7,3	9,1	1,09	1,5	Y100L <sub>1</sub> -4	60	1,9	165			
	41,3	11,5	8,3	1,35	2,2	2.2KW	70	2				
	49,6	13,8	7,8	1,50	2,2		70	2,3				
80-65-260	36,0	10,0	24,5	1450	4,00	5,5	Y132M-4	60	2	264		
	60,0	16,7	22,5		5,25	7,5	7.5KW	70	2,3			
	72,0	20,0	20,6		5,77	7,5		70	3			
80-65-260	34,8	9,7	22,9		3,67	5,5	Y132M-4	59	2	255		
	58,0	16,1	21,0		4,80	7,5	7.5KW	69	2,3			
	69,5	19,3	19,2		5,27	7,5		69	3			
80-65-260	33,4	9,3	21,1		3,31	5,5	Y132S-4	58	2	245		
	55,7	15,5	19,4		4,32	5,5	5.5KW	68	2,3			
	66,8	18,6	17,7		4,75	5,5		68	3			



Модель	Расход		Напор	Скорос ть	Power		модель двигателя	КПД	NPS HR	Рабочее колесо	Диаметр фланца	
					На валу	Двиг.					Вход	Выход
	м3/ч	Л/с	М	Об/мин	кВт	кВт	%	м	мм	мм	мм	
80-65-260	32,0	8,9	19,4	1450	2,97	4	Y132S-4	57	2	235	80	65
	53,4	14,8	17,8		3,87	5,5	5.5KW	67	2,3			
	64,1	17,8	16,3		4,25	5,5		67	3			
80-65-260	30,7	8,5	17,8		2,65	4	Y132S-4	56	2	225		
	51,1	14,2	16,3		3,45	5,5	5.5KW	66	2,3			
	61,4	17,0	15,0		3,79	5,5		66	3			
80-65-260	29,3	8,1	16,2		2,34	4	Y132S-4	56	2	215		
	48,9	13,6	14,9		3,03	5,5	5.5KW	66	2,3			
	58,6	16,3	13,7		3,33	5,5		66	3			
80-65-320	40,0	11,1	37,0	7,46	11	Y160L-4	54	1,9	329			
	65,0	18,1	34,0	9,55	11	15KW	63	2				
	78,0	21,7	31,0	10,62	15		62	2,5				
80-65-320	37,0	10,3	33,4	6,73	11	Y160M-4	50	1,9	315			
	62,0	17,2	30,9	8,55	11	11KW	61	2				
	74,5	20,7	28,0	9,46	11		60	2,3				
80-65-320	34,0	9,4	30,5	5,76	7,5	Y160M-4	49	2	300			
	56,5	15,7	28,0	7,18	11	11KW	60	2				
	68,0	18,9	25,8	8,09	11		59	2,1				
80-65-320	32,3	9,0	27,5	5,04	7,5	Y160M-4	48	2	285			
	53,7	14,9	25,3	6,26	11	11KW	59	2				
	64,6	17,9	23,3	7,06	11		58	2,1				
80-65-320	30,6	8,5	24,7	4,38	7,5	Y132M-4	47	2	270			
	50,9	14,1	22,7	5,41	7,5	7.5KW	58	2				
	61,2	17,0	20,9	6,11	7,5		57	2,1				
80-65-320	28,9	8,0	22,0	3,73	7,5	Y132M-4	47	2	255			
	48,0	13,3	20,2	4,60	7,5	7.5KW	58	2				
	57,8	16,1	18,6	5,19	7,5		57	2,1				
100-80-160	50,0	13,9	9,9	2,21	3	Y100L <sub>2</sub> -4	61	2,1	174			
	80,0	22,2	9,0	2,55	3	3KW	77	2,5				
	96,0	26,7	8,3	2,75	3		79	3,2				
100-80-160	47,4	13,2	8,9	1,90	3	Y100L <sub>2</sub> -4	61	2,1	165			
	75,9	21,1	8,1	2,18	3	3KW	77	2,5				
	91,0	25,3	7,5	2,36	3		79	3,2				
100-80-160	45,0	12,5	7,9	1,60	2,2	Y100L <sub>1</sub> -4	60	2,1	155			
	71,9	20,0	7,1	1,84	2,2	2.2KW	76	2,5				
	86,3	24,0	6,6	1,98	2,2		78	3,2				
100-80-160	42,6	11,8	6,9	1,34	2,2	Y100L <sub>1</sub> -4	60	2,1	145			
	68,2	18,9	6,3	1,54	2,2	2.2KW	76	2,5				
	81,9	22,7	5,8	1,66	2,2		78	3,2				
100-80-160	40,4	11,2	6,0	1,11	2,2	Y100L <sub>1</sub> -4	59	2,1	135			
	64,7	18,0	5,4	1,27	2,2	2.2KW	75	2,5				
	77,6	21,6	5,0	1,37	2,2		77	3,2				



Модель	Расход		Напор	Скорос ть	Power		модель двигателя	КПД	NPS HR	Рабочее колесо	Диаметр фланца		
					На валу	Двиг.					Вход	Выход	
	м3/ч	л/с	М	Об/мин	кВт	кВт	%	м	мм	мм			мм
100-80-200	58,0	16,1	15,5	1450	3,77	5,5	Y132M-4	65	2,1	214	100	80	
	95,0	26,4	14,0		4,64	7,5	7.5KW	78	2,5				
	112,0	31,1	13,0		5,15	7,5		77	3,2				
100-80-200	55,6	15,4	14,2		3,36	5,5	Y132S-4	64	2,1	205			
	91,0	25,3	12,8		4,13	5,5	5.5KW	77	2,5				
	107,3	29,8	11,9		4,58	5,5		76	3,2				
100-80-200	52,9	14,7	12,9		2,94	4	Y132S-4	63	2,1	195			
	86,6	24,0	11,6		3,60	5,5	5.5KW	76	2,5				
	102,1	28,3	10,8		4,00	5,5		75	3,2				
100-80-200	50,1	13,9	11,6		2,53	3	Y112 M-4	63	2,1	185			
	82,1	22,8	10,5		3,10	4	4KW	76	2,5				
	96,8	26,9	9,7		3,44	4		75	3,2				
100-80-200	47,4	13,2	10,4		2,16	3	Y112 M-4	62	2,1	175			
	77,7	21,6	9,4		2,64	4	4KW	75	2,5				
	91,6	25,4	8,7		2,93	4		74	3,2				
100-80-200	43,6	12,1	9,2		1,78	3	Y112 M-4	62	2,1	165			
	71,4	19,8	8,3		2,17	4	4KW	75	2,5				
	84,2	23,4	7,7		2,41	4		74	3,2				
100-80-260	58,0	16,1	23,5		1450	5,80	7,5	Y160M-4	64	2,1			264
	95,0	26,4	21,5			7,51	11	11KW	74	2,5			
	112,0	31,1	20,0			8,35	11		73	3,2			
100-80-260	56,0	15,6	21,9	5,31		7,5	Y160M-4	63	2,1	255			
	91,8	25,5	20,1	6,86		11	11KW	73	2,5				
	108,2	30,1	18,7	7,63		11		72	3,2				
100-80-260	53,8	15,0	20,2	4,78		7,5	Y160M-4	62	2,1	245			
	88,2	24,5	18,5	6,17		11	11KW	72	2,5				
	103,9	28,9	17,2	6,86		11		71	3,2				
100-80-260	51,6	14,3	18,6	4,29		5,5	Y132M-4	61	2,1	235			
	84,6	23,5	17,0	5,52		7,5	7.5KW	71	2,5				
	99,7	27,7	15,8	6,14		7,5		70	3,2				
100-80-260	47,3	13,1	17,1	3,67		5,5	Y132M-4	60	2,1	225			
	77,5	21,5	15,6	4,71		7,5	7.5KW	70	2,5				
	91,4	25,4	14,5	5,24		7,5		69	3,2				
100-80-260	45,2	12,6	15,6	3,22		4	Y132S-4	60	2,1	215			
	74,1	20,6	14,3	4,14		5,5	5.5KW	70	2,5				
	87,3	24,3	13,3	4,60		5,5		69	3,2				
100-80-320	60,0	16,7	36,0	1450		9,64	15	Y180M-4	61	1,9	329		
	100,0	27,8	33,0			12,65	15	18.5KW	71	2			
	120,0	33,3	30,0			14,00	18,5		70	2,6			
100-80-320	57,5	16,0	32,4		8,74	11	Y160L-4	58	1,9	315			
	95,5	26,5	29,7		11,19	15	15KW	69	2				
	114,5	31,8	27,0		12,38	15		68	2,3				



Модель	Расход		Напор	Скорость	Power		модель двигателя	КПД	NPS HR	Рабочее колесо	Диаметр фланца			
					На валу	Двиг.					Вход	Выход		
	мЗл	Л/с	М	Об/мин	кВт	кВт	%	м	мм	мм	мм			
100-80-320	54,5	15,1	29,3	1450	7,76	11	Y160L-4	56	1,9	300	100	80		
	91,0	25,3	26,8		9,91	15	15KW	67	2					
	109,0	30,3	24,5		11,01	15		66	2,2					
100-80-320	51,8	14,4	26,4		6,78	11	Y160L-4	55	1,9	285				
	86,5	24,0	24,2		8,62	11	15KW	66	2					
	103,6	28,8	22,1		9,59	15		65	2,2					
100-80-320	49,1	13,6	23,7		5,87	7,5	Y160M-4	54	1,9	270				
	81,9	22,8	21,7		7,45	11	11KW	65	2					
	98,1	27,3	19,8		8,28	11		64	2,2					
100-80-320	46,3	12,9	21,2		4,99	7,5	Y160M-4	54		255				
	77,4	21,5	19,4		6,32	11	11KW	65						
	92,7	25,7	17,7		7,03	11		64						
100-80-400	60,0	16,7	58,0		18,95	22	Y200L-4	50	2,2	409			100	80
	100,0	27,8	53,0		24,05	30	30KW	60	2,5					
	120,0	33,3	48,0		26,58	30		59	3,4					
100-80-400	58,0	16,1	53,7	17,66	22	Y200L-4	48	2,2	395					
	96,5	26,8	48,9	22,15	30	30KW	58	2,4						
	116,0	32,2	44,4	24,60	30		57	3,2						
100-80-400	56,0	15,6	49,4	16,37	22	Y200L-4	46	2,2	380					
	93,0	25,8	45,0	20,34	30	30KW	56	2,4						
	111,5	31,0	40,9	22,57	30		55	3						
100-80-400	54,0	15,0	46,0	15,03	18,5	Y180L-4	45	2,2	365	100	80			
	90,0	25,0	42,0	18,71	22	22KW	55	2,3						
	108,0	30,0	38,0	20,69	22		54	2,8						
100-80-400	51,8	14,4	42,3	13,87	15	Y180L-4	43	2,2	350					
	86,3	24,0	38,6	17,12	18,5	22KW	53	2,3						
	103,6	28,8	34,9	18,94	22		52	2,8						
100-80-400	49,6	13,8	38,7	12,30	15	Y180L-4	43	2,2	335					
	82,6	22,9	35,4	15,15	18,5	22KW	53	2,3						
	99,1	27,5	32,0	16,77	22		52	2,8						
125-100-160	86,0	23,9	9,5	3,18	4	Y112 M-4	70	2,3	190	125	100			
	100,0	27,8	8,7	3,29	4	4KW	72	2,5						
	135,0	37,5	6,0	3,68	4		60	3,3						
125-100-160	81,5	22,6	8,5	2,72	3	Y112 M-4	70	2,3	180					
	94,7	26,3	7,8	2,82	3	4KW	72	2,5						
	127,9	35,5	5,4	3,15	4		60	3,3						
125-100-160	76,9	21,4	7,6	2,31	3	Y100L2-4	69	2,3	170					
	89,5	24,9	7,0	2,39	3	3KW	71	2,5						
	120,8	33,6	4,8	2,68	3		59	3,3						
125-100-160	72,4	20,1	6,7	1,94	2,2	Y100L2-4	69	2,3	160					
	84,2	23,4	6,2	2,01	2,2	3KW	71	2,5						
	113,7	31,6	4,3	2,25	3		59	3,3						



Модель	Расход		Напор	Скорос ть	Power		модель двигателя	КПД	NPS HR	Рабочее колесо	Диаметр фланца	
					На валу	Двиг.					Вход	Выход
	м3/ч	Л/с	М	Об/мин	кВт	кВт	%	м	мм	мм		
125-100-200	90,0	25,0	15,0	1450	5,25	7,5	Y160M-4	70	2,2	214	125	100
	142,0	39,4	13,0		6,36	7,5	11KW	79	2,5			
	170,0	47,2	11,5		6,91	11		77	3,4			
125-100-200	86,2	23,9	13,8		4,68	5,5	Y132M-4	69	2,2	205		
	136,0	37,8	11,9		5,66	7,5	7.5KW	78	2,5			
	162,9	45,2	10,6		6,16	7,5		76	3,4			
125-100-200	82,0	22,8	12,5		4,09	5,5	Y132M-4	68	2,2	195		
	129,4	35,9	10,8		4,94	5,5	7.5KW	77	2,5			
	154,9	43,0	9,5		5,37	7,5		75	3,4			
125-100-200	77,8	21,6	11,2		3,52	4	Y132S-4	68	2,2	185		
	122,8	34,1	9,7		4,24	5,5	5.5KW	77	2,5			
	147,0	40,8	8,6		4,62	5,5		75	3,4			
125-100-200	71,5	19,9	9,5		2,75	4	Y132S-4	67	2,2	175		
	112,8	31,3	8,2		3,31	4	5.5KW	76	2,5			
	135,0	37,5	7,3		3,61	5,5		74	3,4			
125-100-200	69,4	19,3	8,4		2,39	3	Y112 M-4	67	2,2	165		
	109,5	30,4	7,3		2,88	4	4KW	76	2,5			
	131,1	36,4	6,5		3,13	4		74	3,4			
125-100-260	95,0	26,4	24,5		9,18	11	Y160L-4	69	2,3	264		
	148,0	41,1	22,0		11,36	15	15KW	78	2,6			
	175,0	48,6	20,0		12,54	15		76	3,5			
125-100-260	91,8	25,5	22,9	8,40	11	Y160L-4	68	2,3	255			
	143,0	39,7	20,5	10,37	11	15KW	77	2,6				
	169,0	47,0	18,7	11,45	15		75	3,5				
125-100-260	88,2	24,5	21,1	7,56	7,5	Y160M-4	67	2,3	245			
	137,3	38,2	18,9	9,32	11	11KW	76	2,6				
	162,4	45,1	17,2	10,29	11		74	3,5				
125-100-260	84,6	23,5	19,4	6,77	7,5	Y160M-4	66	2,3	235			
	131,7	36,6	17,4	8,33	11	11KW	75	2,6				
	155,8	43,3	15,8	9,20	11		73	3,5				
125-100-260	81,0	22,5	17,8	6,03	7,5	Y160M-4	65	2,3	225			
	126,1	35,0	16,0	7,41	7,5	11KW	74	2,6				
	149,2	41,4	14,5	8,19	11		72	3,5				
125-100-260	77,4	21,5	16,2	5,30	7,5	Y160M-4	65	2,3	215			
	120,5	33,5	14,6	6,51	7,5	11KW	74	2,6				
	142,5	39,6	13,3	7,20	11		72	3,5				
125-100-320	81,0	22,5	37,5	12,72	15	Y180L-4	65	2	329			
	135,0	37,5	34,0	16,66	22	22KW	75	2				
	162,0	45,0	30,0	18,38	22		72	2,3				
125-100-320	77,5	21,5	33,5	11,49	15	Y180L-4	62	2	315			
	130,0	36,1	30,5	15,20	22	22KW	71	2				
	155,0	43,1	27,0	16,63	22		69	2,18				



Модель	Расход		Напор	Скорос ть	Power		модель двигателя	КПД	NPS HR	Рабочее колесо	Диаметр фланца		
					На валу	Двиг.					Вход	Выход	
	мЗ/ч	Л/с	М	Об/мин	кВт	кВт	%	м	мм	мм	мм		
125-100-320	73,5	20,4	30,5	1450	10,43	15	Y180M-4	59	2	300	125	100	
	123,0	34,2	27,5		13,54	18,5	18.5KW	68	2				
	147,5	41,0	24,5		14,91	18,5		66	2,1				
125-100-320	69,8	19,4	27,5		9,10	11	Y160L-4	58	2	285			
	116,9	32,5	24,8		11,78	15	15KW	67	2				
	140,1	38,9	22,1		12,98	15		65	2,1				
125-100-320	66,1	18,4	24,7		7,87	11	Y160L-4	57	2	270			
	110,7	30,7	22,3		10,17	11	15KW	66	2				
	132,7	36,9	19,8		11,21	15		64	2,1				
125-100-320	62,5	17,4	22,0		6,69	11	Y160L-4	56	2	255			
	104,5	29,0	19,9		8,63	11	15KW	66	2				
	125,4	34,8	17,7		9,51	15		64	2,1				
125-100-400	90,0	25,0	57,0		1450	24,08	30	Y225M-4	58	1,7			409
	150,0	41,7	52,0			31,23	37	45KW	68	2			
	180,0	50,0	48,5			34,95	45		68	2,7			
125-100-400	87,0	24,2	52,5			22,20	30	Y225S-4	56	1,7			395
	145,0	40,3	48,2			28,83	37	37KW	66	2			
	174,0	48,3	44,5			31,74	37		66	2,5			
125-100-400	84,0	23,3	48,5	20,54		30	Y225S-4	54	1,7	380			
	139,5	38,8	44,5	26,40		37	37KW	64	1,9				
	167,5	46,5	41,2	29,35		37		64	2,4				
125-100-400	81,0	22,5	45,0	19,08		22	Y200L-4	52	1,7	365			
	135,0	37,5	41,0	24,30		30	30KW	62	1,9				
	162,0	45,0	38,0	27,03		30		62	2,3				
125-100-400	77,7	21,6	41,4	17,15		22	Y200L-4	51	1,7	350			
	129,5	36,0	37,7	21,78		22	30KW	61	1,9				
	155,3	43,2	34,9	24,22		30		61	2,3				
125-100-400	74,3	20,7	37,9	15,19		22	Y200L-4	51	1,7	335			
	123,9	34,4	34,5	19,25		22	30KW	61	1,9				
	148,7	41,3	32,0	21,42		30		61	2,3				
150-125-200	115,0	32,0	14,2	1450		7,29	11	Y160M-4	61	2,6	214		
	190,0	53,0	12,5			8,51	11	11KW	76	3,5			
	230,0	63,6	11,0			9,06	11		76	3			
150-125-200	110,0	30,6	13,0			6,49	11	Y160M-4	60	2,6	205		
	182,0	50,6	11,5			7,60	11	11KW	75	3,5			
	220,0	61,1	10,1			8,07	11		75	3			
150-125-200	104,6	29,1	11,8		5,68	7,5	Y132M-4	59	2,6	195			
	173,1	48,1	10,4		6,63	7,5	7.5KW	74	3,5				
	209,3	58,1	9,1		7,04	7,5		74	3				
150-125-200	99,3	27,6	10,6		4,89	7,5	Y132M-4	59	2,6	185			
	164,2	45,6	9,4		5,70	7,5	7.5KW	74	3,5				
	198,5	55,1	8,2		6,05	7,5		74	3				





Модель	Расход		Напор	Скорос ть	Power		модель двигателя	КПД	NPS HR	Рабочее колесо	Диаметр фланца	
					На валу	Двиг.					Вход	Выход
	м3/ч	Л/с	М		Об/мин	кВт	кВт	%	м	мм	мм	мм
150-125-260	144,0	40,0	23,5	1450	13,16	18,5	Y180L-4	70	2,3	264	150	125
	240,0	66,7	21,0		16,94	22	22KW	81	2,5			
	288,0	80,0	18,8		18,90	22		78	3,2			
150-125-260	139,0	38,6	21,3		12,03	15	Y180L-4	67	2,3	255		
	232,0	64,4	19,2		15,35	22	22KW	79	2,5			
	278,5	77,4	17,0		16,96	22		76	3			
150-125-260	134,0	37,2	19,7		11,23	15	Y180M-4	64	2,3	245		
	223,0	61,9	17,5		13,98	18,5	18.5KW	76	2,4			
	267,5	74,3	15,7		15,45	18,5		74	2,8			
150-125-260	128,5	35,7	18,1		10,07	11	Y160L-4	63	2,3	235		
	213,9	59,4	16,1		12,50	15	15KW	75	2,4			
	256,6	71,3	14,4		13,82	15		73	2,8			
150-125-260	123,1	34,2	16,6		8,98	11	Y160L-4	62	2,3	225		
	204,8	56,9	14,8		11,12	11	15KW	74	2,4			
	245,7	68,2	13,2		12,30	15		72	2,8			
150-125-260	117,6	32,7	15,2		7,90	11	Y160L-4	62	2,3	215		
	195,7	54,4	13,5		9,77	11	15KW	74	2,4			
	234,7	65,2	12,1		10,81	15		72	2,8			
150-125-320	120,0	33,3	35,1		18,35	18,5	Y200L-4	63	2,15	329		
	200,0	55,6	32,0		23,23	30	30KW	75	1,95			
	240,0	66,7	29,5		25,87	30		75	2,4			
150-125-320	115,0	31,9	31,5	14,94	22	Y200L-4	66	2,1	315			
	191,0	53,1	29,0	19,33	30	30KW	78	2				
	229,0	63,6	26,5	21,18	30		78	2,7				
150-125-320	109,0	30,3	28,5	14,09	18,5	Y180L-4	60	2,2	300			
	182,0	50,6	26,0	17,77	22	22KW	73	2				
	218,5	60,7	24,0	19,69	22		73	2,2				
150-125-320	103,6	28,8	25,7	12,29	15	Y180M-4	59	2,2	285			
	172,9	48,0	23,5	15,45	18,5	18.5KW	72	2				
	207,6	57,7	21,7	17,12	18,5		72	2,2				
150-125-320	98,1	27,2	23,1	10,63	11	Y160L-4	58	2,2	270			
	163,8	45,5	21,1	13,32	15	15KW	71	2				
	196,6	54,6	19,4	14,76	15		71	2,2				
150-125-320	92,6	25,7	20,6	9,03	11	Y160L-4	58	2,2	255			
	154,7	43,0	18,8	11,30	15	15KW	70	2				
	185,7	51,6	17,3	12,52	15		70	2,2				
150-125-400	144,0	40,0	58,0	34,45	45	Y280S-4	66	2,2	409			
	245,0	68,1	52,0	45,63	55	75KW	76	2,4				
	300,0	83,3	46,0	52,18	75		72	3,2				
150-125-400	139,0	38,6	53,5	31,39	37	Y250M-4	65	2,2	395			
	236,5	65,7	48,0	41,76	55	55KW	74	2,4				
	289,0	80,4	42,5	47,77	55		70	3				



Модель	Расход		Напор	Скорость	Power		модель двигателя	КПД	NPS HR	Рабочее колесо	Диаметр фланца				
					На валу	Двиг.					Вход	Выход			
	м3/ч	Л/с	М	Об/мин	кВт	кВт	%	м	мм	мм	мм				
150-125-400	133,5	37,1	49,5	1450	28,55	37	Y250M-4	63	2,2	380	150	125			
	227,5	63,2	44,0		37,59	45	55KW	73	2,3						
	278,5	77,4	39,0		43,16	55		69	2,8						
150-125-400	132,0	36,7	44,8		25,96	30	Y225M-4	62	2,2	365					
	220,0	61,1	40,7		34,33	45	45KW	71	2,3						
	264,0	73,3	36,3		38,94	45		67	2,8						
150-125-400	126,6	35,2	41,2		23,27	30	Y225S-4	61	2,2	350					
	211,0	58,6	37,4		30,70	37	37KW	70	2,3						
	253,2	70,3	33,4		34,85	37		66	2,8						
150-125-400	121,2	33,7	37,7		20,57	30	Y225S-4	61	2,2	335					
	201,9	56,1	34,3		27,12	37	37KW	70	2,3						
	242,3	67,3	30,6		30,79	37		66	2,8						
200-150-200	216,0	60,0	14,4		1450	12,10	15	Y180M-4	70	3			214	200	150
	360,0	100,0	12,2			14,95	18,5	18.5KW	80	3,5					
	424,8	118,0	10,3			15,47	18,5		77	4					
200-150-200	206,9	57,5	13,2	10,71		11	Y160L-4	70	3	205					
	344,9	95,8	11,2	13,22		15	15KW	80	3,5						
	406,9	113,0	9,5	13,69		15		77	4						
200-150-200	196,8	54,7	12,0	9,28		11	Y160L-4	69	3	195					
	328,0	91,1	10,1	11,45		15	15KW	79	3,5						
	387,1	107,5	8,6	11,86		15		76	4						
200-150-200	186,7	51,9	10,8	7,99		11	Y160L-4	69	3	185					
	311,2	86,4	9,1	9,84		15	15KW	79	3,5						
	367,2	102,0	7,7	10,19		15		76	4						
200-150-200	176,6	49,1	9,6	6,81		11	Y160M-4	68	3	175					
	294,4	81,8	8,2	8,38		11	11KW	78	3,5						
	347,4	96,5	6,9	8,68		11		75	4						
200-150-260	194,0	54,0	23,0	1450	17,11	22	Y200L-4	71	2,7	264	200	150			
	324,0	90,0	21,0		22,87	30	30KW	81	3						
	414,0	115,0	16,8		25,59	30		74	3,3						
200-150-260	186,7	51,9	21,5		15,58	18,5	Y200L-4	70	2,7	255					
	311,8	86,6	19,6		20,79	22	30KW	80	3						
	398,4	110,7	15,7		23,29	30		73	3,3						
200-150-260	179,4	49,8	19,8		14,02	15	Y180L-4	69	2,7	245					
	299,5	83,2	18,1		18,67	22	22KW	79	3						
	382,8	106,3	14,5		20,94	22		72	3,3						
200-150-260	172,0	47,8	18,2		12,55	15	Y180L-4	68	2,7	235					
	287,3	79,8	16,6		16,68	18,5	22KW	78	3						
	367,1	102,0	13,3		18,74	22		71	3,3						
200-150-260	164,7	45,8	16,7		11,10	15	Y180L-4	68	2,7	225					
	275,1	76,4	15,3		14,74	18,5	22KW	78	3						
	351,5	97,6	12,2		16,56	22		71	3,3						



Модель	Расход		Напор	Скорость	Power		модель двигателя	КПД	NPS HR	Рабочее колесо	Диаметр фланца	
					На валу	Двиг.					Вход	Выход
	м3/ч	Л/с	М	Об/мин	кВт	кВт	%	м	мм	мм	мм	
200-150-260	157,4	43,7	15,3	1450	9,75	15	Y180M-4	67	2,7	215	200	150
	262,9	73,0	13,9		12,94	18,5	18.5KW	77	3			
	335,9	93,3	11,1		14,55	18,5		70	3,3			
200-150-320	230,0	63,9	36,0	1450	30,88	37	Y250M-4	73	2,8	329	200	150
	370,0	102,8	33,0		40,53	45	55KW	82	3,2			
	445,0	123,6	30,0		44,87	55		81	3,6			
200-150-320	220,0	61,1	32,5	1450	27,61	37	Y225M-4	71	2,8	315	200	150
	354,0	98,3	30,0		36,36	45	45KW	80	3,1			
	426,0	118,3	27,0		39,89	45		79	3,5			
200-150-320	209,5	58,2	29,5	1450	24,38	30	Y225S-4	69	2,8	300	200	150
	337,5	93,8	27,0		31,80	37	37KW	78	3			
	405,5	112,6	24,5		35,12	37		77	3,3			
200-150-320	199,0	55,3	26,6	1450	21,21	22	Y225S-4	68	2,8	285	200	150
	320,6	89,1	24,4		27,62	30	37KW	77	3			
	385,2	107,0	22,1		30,51	37		76	3,3			
200-150-320	188,6	52,4	23,9	1450	18,31	22	Y200L-4	67	2,8	270	200	150
	303,8	84,4	21,9		23,79	30	30KW	76	3			
	365,0	101,4	19,8		26,29	30		75	3,3			
200-150-320	178,1	49,5	21,3	1450	15,54	22	Y200L-4	67	2,8	255	200	150
	286,9	79,7	19,5		20,18	30	30KW	76	3			
	344,7	95,7	17,7		22,29	30		75	3,3			
200-150-400	240,0	66,7	54,0	1450	51,13	75	Y280M-4	69	2,8	409	200	150
	385,0	106,9	50,0		66,33	75	90KW	79	3,2			
	460,0	127,8	46,0		73,85	90		78	3,6			
200-150-400	232,0	64,4	50,0	1450	46,78	55	Y280S-4	68	2,8	395	200	150
	372,0	103,3	46,0		60,50	75	75KW	77	3,2			
	444,0	123,3	42,5		65,86	75		78	3,6			
200-150-400	223,0	61,9	46,0	1450	42,31	55	Y280S-4	66	2,8	380	200	150
	357,5	99,3	42,0		54,14	75	75KW	76	3,1			
	427,5	118,8	39,0		60,92	75		75	3,5			
200-150-400	204,0	56,7	43,5	1450	37,16	45	Y250M-4	65	2,8	365	200	150
	340,0	94,4	38,3		47,27	55	55KW	75	3			
	408,0	113,3	34,9		52,38	55		74	3,4			
200-150-400	195,6	54,3	40,0	1450	33,28	37	Y250M-4	64	2,8	350	200	150
	326,0	90,6	35,2		42,24	45	55KW	74	3			
	391,2	108,7	32,1		46,82	55		73	3,4			
200-150-400	190,1	52,8	37,8	1450	31,03	37	Y250M-4	63	2,8	335	200	150
	316,8	88,0	33,3		39,30	45	55KW	73	3			
	380,2	105,6	30,3		43,57	55		72	3,4			
250-200-260	360,0	100,0	20,0	1450	30,63	30	Y200L-4	64	3,7	288	250	200
	600,0	166,7	15,2		31,03	30	30KW	80	2,8			
	720,0	200,0	12,0		29,77	30		79	3,6			



Модель	Расход		Напор	Скорость	Power		модель двигателя	КПД	NPS HR	Рабочее колесо	Диаметр фланца	
					На валу	Двиг.					Вход	Выход
	м3/ч	Л/с	М	Об/мин	кВт	кВт	%	м	мм	мм	мм	
250-200-260	337,5	93,8	17,6	1450	25,43	22	Y180L-4	64	3,7	270	250	200
	562,5	156,3	13,4		25,73	22	22KW	80	2,8			
	675,0	187,5	10,5		24,69	22		79	3,6			
250-200-260	318,8	88,5	15,7		21,60	15	Y180M-4	63	3,7	255		
	531,3	147,6	11,9		21,81	18,5	18.5KW	79	2,8			
	637,5	177,1	9,4		20,93	18,5		78	3,6			
250-200-260	300,0	83,3	13,9		18,15	15	Y160L-4	63	3,7	240		
	498,0	138,3	10,6		18,23	15	15KW	79	2,8			
	597,7	166,0	8,3		17,49	15		78	3,6			
250-200-320	378,0	105,0	33,0		46,52	55	Y280S-4	73	2,7	329		
	630,0	175,0	27,0		54,48	75	75KW	85	3,8			
	756,0	210,0	20,0		56,38	75		73	3,9			
250-200-320	360,0	100,0	30,0	40,27	45	Y250M-4	73	2,6	315			
	600,0	167,0	25,0	50,41	55	55KW	81	3,7				
	720,0	200,0	19,0	51,01	55		73	3,8				
250-200-320	342,0	95,0	28,5	37,37	45	Y250M-4	71	2,5	300			
	570,0	158,0	23,0	44,61	55	55KW	80	3,6				
	684,0	190,0	18,5	47,19	55		73	3,74				
250-200-320	324,0	90,0	25,5	33,08	37	Y225M-4	68	2,5	285			
	540,0	150,0	21,0	40,09	45	45KW	77	3,6				
	648,0	180,0	16,6	41,24	45		71	3,7				
250-200-320	306,9	85,3	22,9	28,54	30	Y225S-4	67	2,5	270			
	511,6	142,1	18,8	34,54	37	37KW	76	3,6				
	613,9	170,5	14,9	35,57	37		70	3,7				
250-200-320	289,9	80,5	20,4	24,23	30	Y225S-4	67	2,5	255			
	483,2	134,2	16,8	29,29	37	37KW	76	3,6				
	579,8	161,1	13,3	30,18	37		70	3,7				
250-200-400	390,0	108,0	55,5	76,52	90	Y315M,-	77	3	409			
	650,0	181,0	48,5	99,79	110	132KW	86	3,8				
	780,0	217,0	41,5	108,79	132		81	4,5				
250-200-400	378,0	105,0	51,0	68,15	75	Y315S-4	77	2,9	395			
	630,0	175,0	44,0	88,78	110	110KW	85	3,8				
	756,0	210,0	37,0	96,39	110		79	4,4				
250-200-400	360,0	100,0	47,0	60,61	75	Y280M-4	76	2,9	380			
	600,0	167,0	40,5	78,75	90	90KW	84	3,7				
	720,0	200,0	33,5	84,18	90		78	4,3				
250-200-400	342,0	95,0	43,0	53,38	75	Y280M-4	75	2,9	365			
	570,0	158,0	36,5	68,24	90	90KW	83	3,7				
	684,0	190,0	30,5	73,75	90		77	4,2				
250-200-400	324,0	90,0	39,0	46,48	55	Y280S-4	74	2,9	350			
	540,0	150,0	32,5	58,26	75	75KW	82	3,6				
	648,0	180,0	27,0	62,67	75		76	4,1				



Модель	Расход		Напор	Скорос ть	Power		модель двигателя	КПД	NPS HR	Рабочее колесо	Диаметр фланца	
					На валу	Двиг.					Вход	Выход
	м <sup>3</sup> /ч	Л/с	М	Об/мин	кВт	кВт	%	м	мм	мм		
250-200-400	306,0	85,0	34,0	1450	39,34	45	Y280S-4	72	2,8	335	250	200
	510,0	142,0	29,0		49,71	55	75KW	81	3,6			
	612,0	170,0	23,5		52,91	75		74	4			
300-250-320	504,0	140,0	32,0	1450	62,72	75	Y280M-4	70	3,2	329	300	250
	840,0	233,0	29,0		77,11	90	90KW	86	3,4			
	1008,0	280,0	23,0		78,89	90		80	5,5			
300-250-320	480,0	133,0	29,0	1450	54,13	75	Y280s-4	70	3,2	315	300	250
	800,0	222,0	26,0		66,61	75	75KW	85	3,2			
	960,0	267,0	21,0		68,60	75		80	4,8			
300-250-320	456,0	127,0	26,5	1450	47,67	55	Y280s-4	69	3,3	300	300	250
	760,0	211,0	23,5		57,88	75	75KW	84	3,1			
	912,0	253,0	19,0		59,71	75		79	4,1			
300-250-320	432,0	120,0	24,0	1450	40,90	45	Y250M-4	69	3,3	285	300	250
	720,0	200,0	21,0		49,59	55	55KW	83	3,1			
	864,0	240,0	17,0		50,61	55		79	3,7			
300-250-320	409,3	113,7	21,5	1450	35,29	37	Y225M-4	68	3,3	270	300	250
	682,1	189,5	18,8		42,68	45	45KW	82	3,1			
	818,5	227,4	15,3		43,59	45		78	3,7			
300-250-320	386,5	107,4	19,2	1450	29,95	37	Y225M-4	68	3,3	255	300	250
	644,2	178,9	16,8		36,17	45	45KW	82	3,1			
	773,1	214,7	13,6		36,95	45		78	3,7			
300-250-400	540,0	150,0	52,5	1450	102,90	132	Y315L <sub>1</sub> -4	75	3,3	409	300	250
	900,0	250,0	48,5		135,03	160	160KW	88	4,8			
	1080,0	300,0	41,0		148,81	160		81	6,3			
300-250-400	522,0	145,0	49,0	1450	92,84	110	Y315L <sub>1</sub> -4	75	3,3	395	300	250
	870,0	242,0	44,5		119,76	132	160KW	88	4,8			
	1044,0	290,0	38,5		133,44	160		82	6,2			
300-250-400	504,0	140,0	45,0	1450	81,24	90	Y315M <sub>1</sub> -	76	3,2	380	300	250
	840,0	233,0	40,5		105,24	132	132KW	88	4,7			
	1008,0	280,0	34,5		112,70	132		84	6,2			
300-250-400	480,0	133,0	41,0	1450	71,43	90	Y315S-4	75	3,1	365	300	250
	800,0	222,0	37,0		91,57	110	110KW	88	4,6			
	960,0	267,0	31,0		96,44	110		84	6			
300-250-400	456,0	127,0	38,0	1450	62,89	75	Y315S-4	75	3	350	300	250
	760,0	211,0	33,5		78,76	90	110KW	88	4,5			
	912,0	253,0	28,5		84,23	110		84	5,8			
300-250-400	432,0	120,0	35,0	1450	55,62	75	Y280M-4	74	3	335	300	250
	720,0	200,0	31,0		69,84	90	90KW	87	4,4			
	864,0	240,0	27,0		76,51	90		83	5,5			

Гидравлические характеристики насосов

BS EN 733/DIN 24255

50-32-130

Performance Curve

2900 rpm

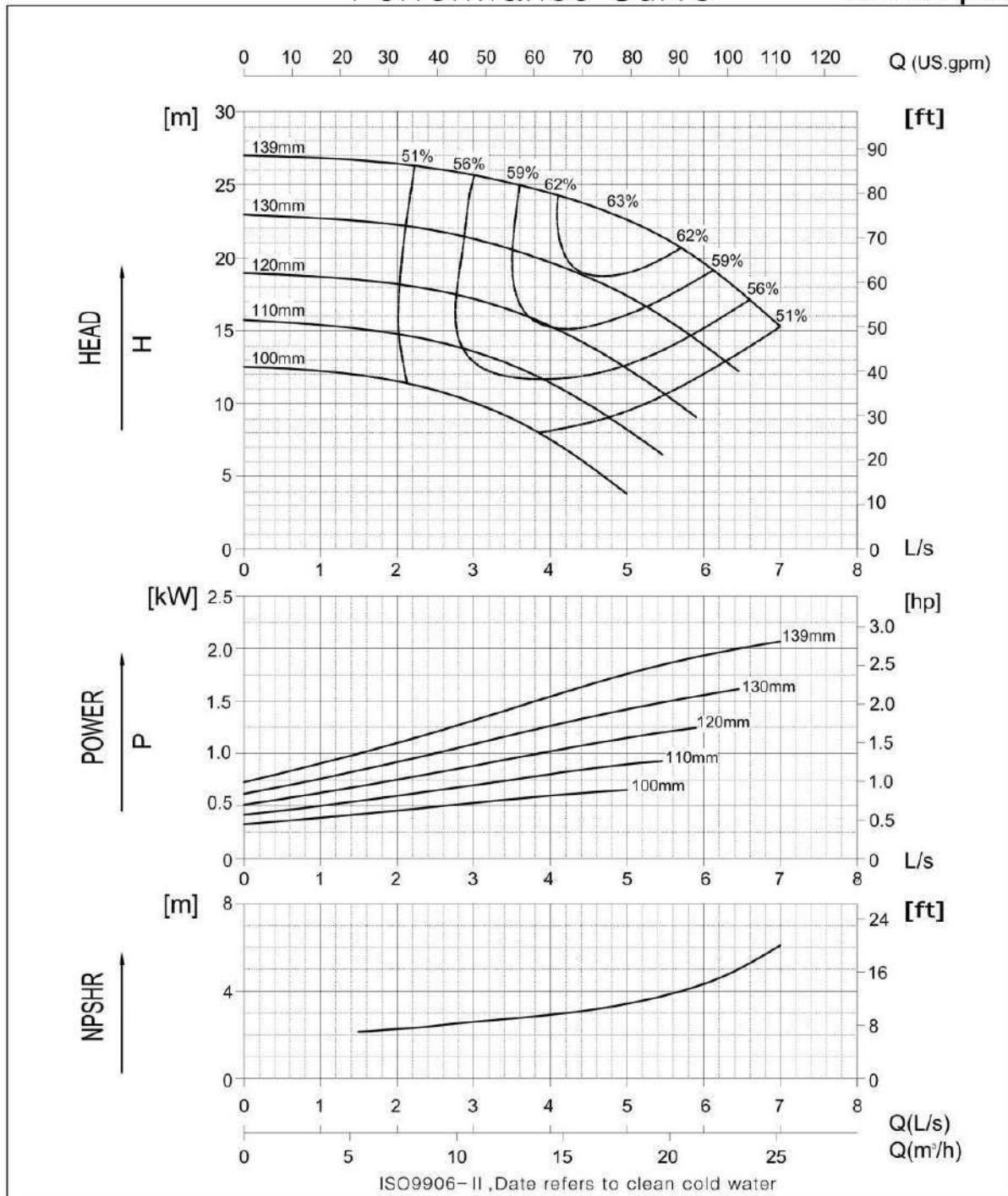

P1701A

BS EN 733/DIN 24255

50-32-160

Performance Curve

2900 rpm

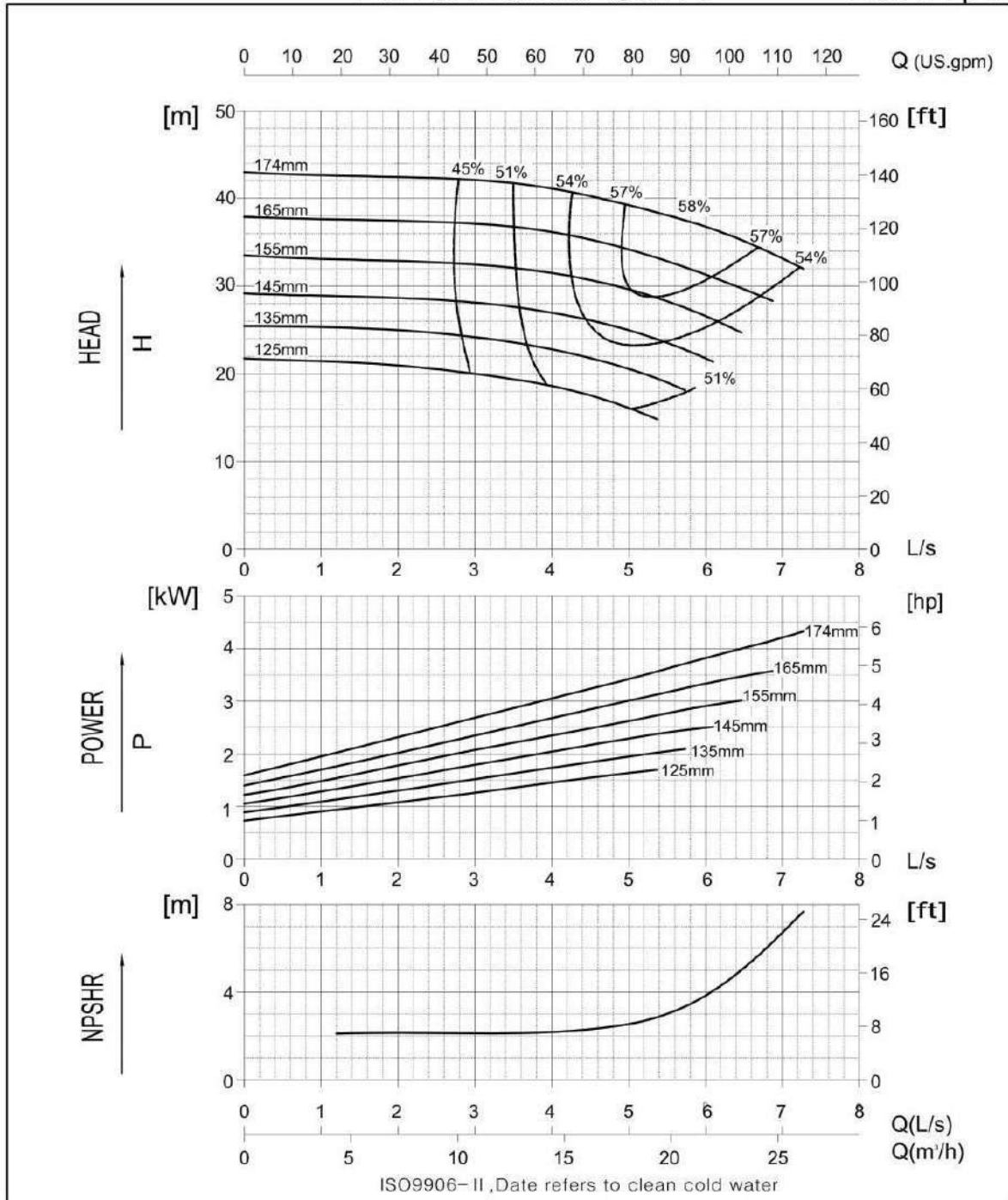

P1701A



BS EN 733/DIN 24255

50-32-200

Performance Curve

2900 rpm

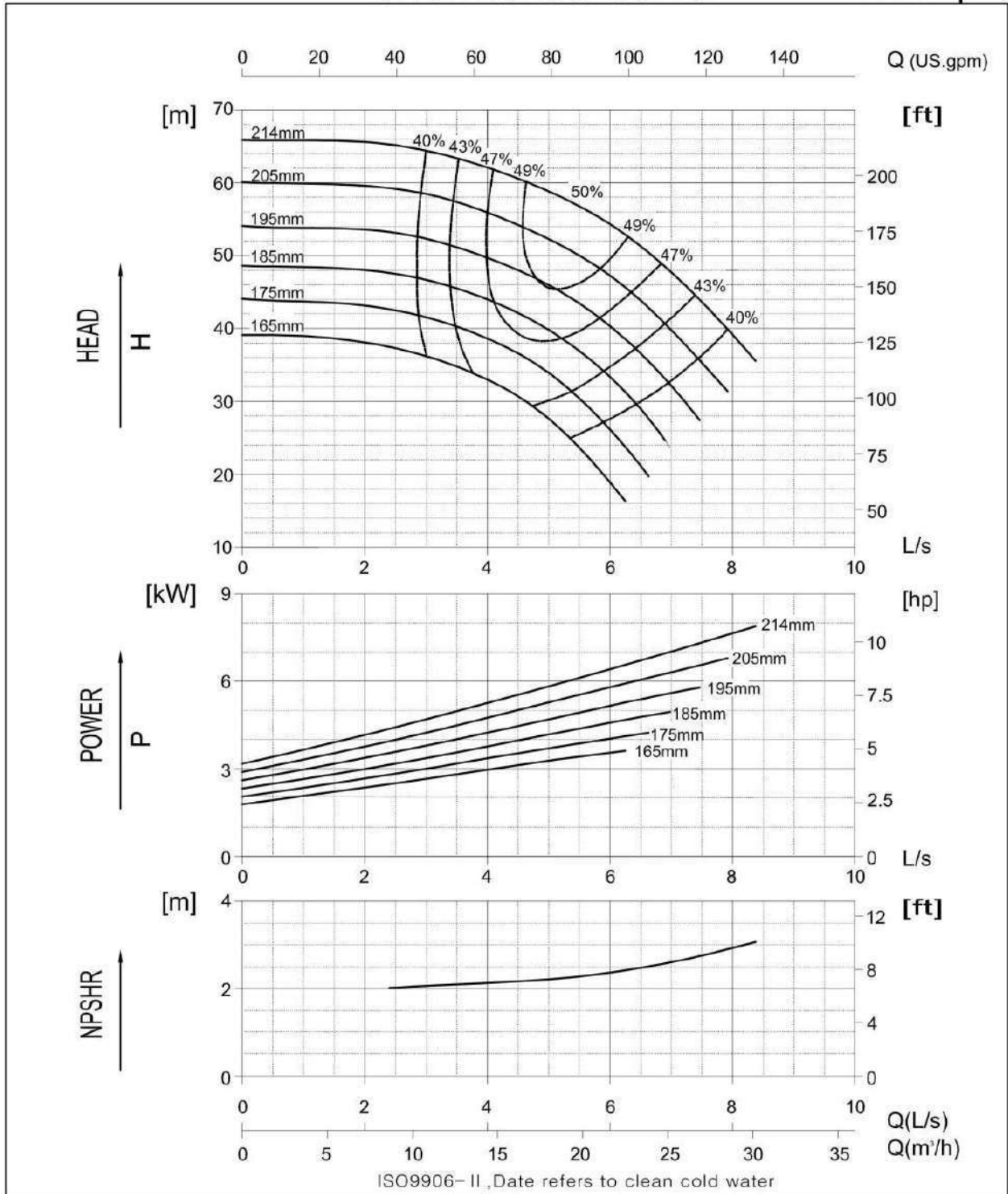

P1701A



BS EN 733/DIN 24255

50-32-260

Performance Curve

2900 rpm

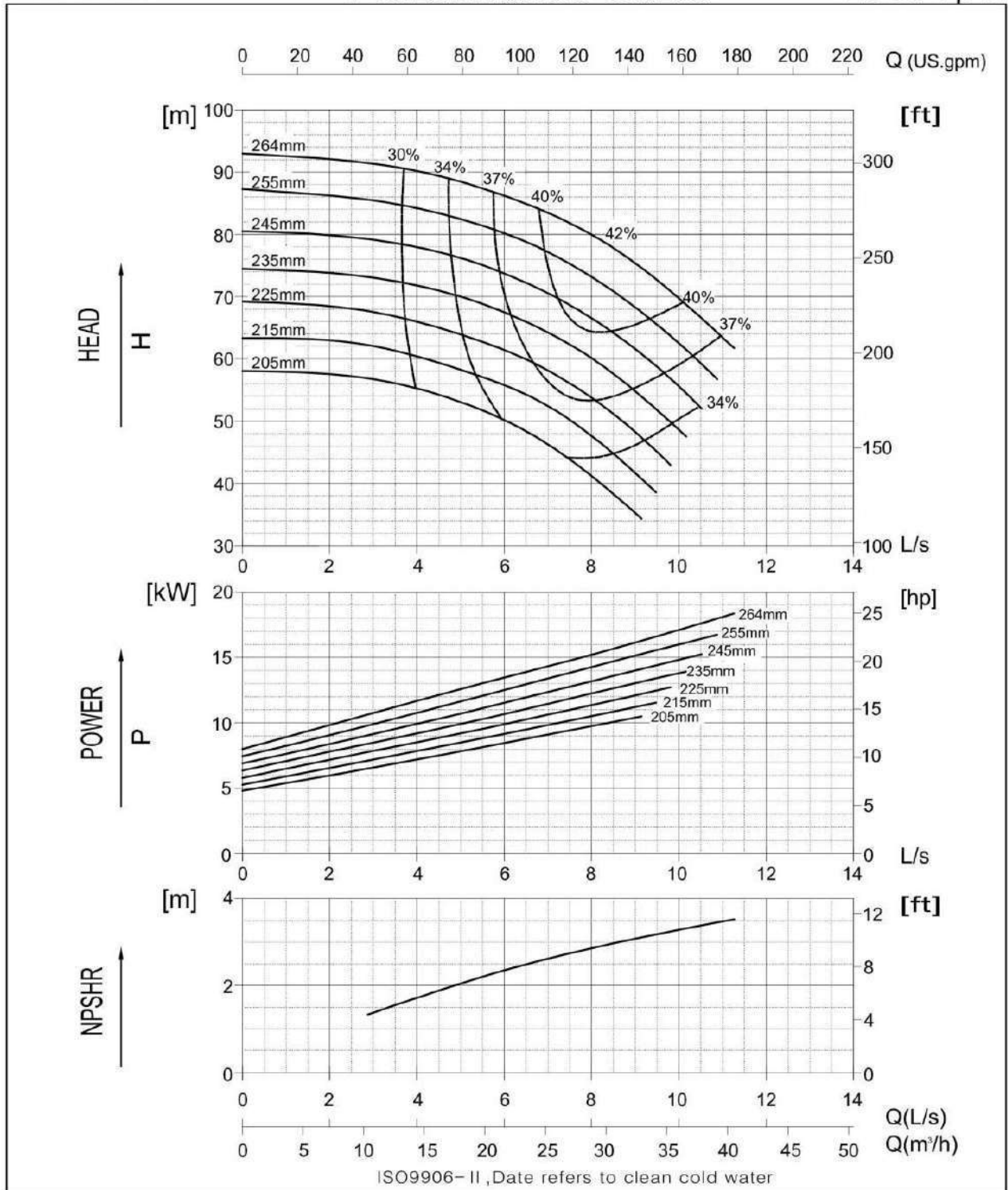

P1701A



BS EN 733/DIN 24255

65-40-130

Performance Curve

2900 rpm

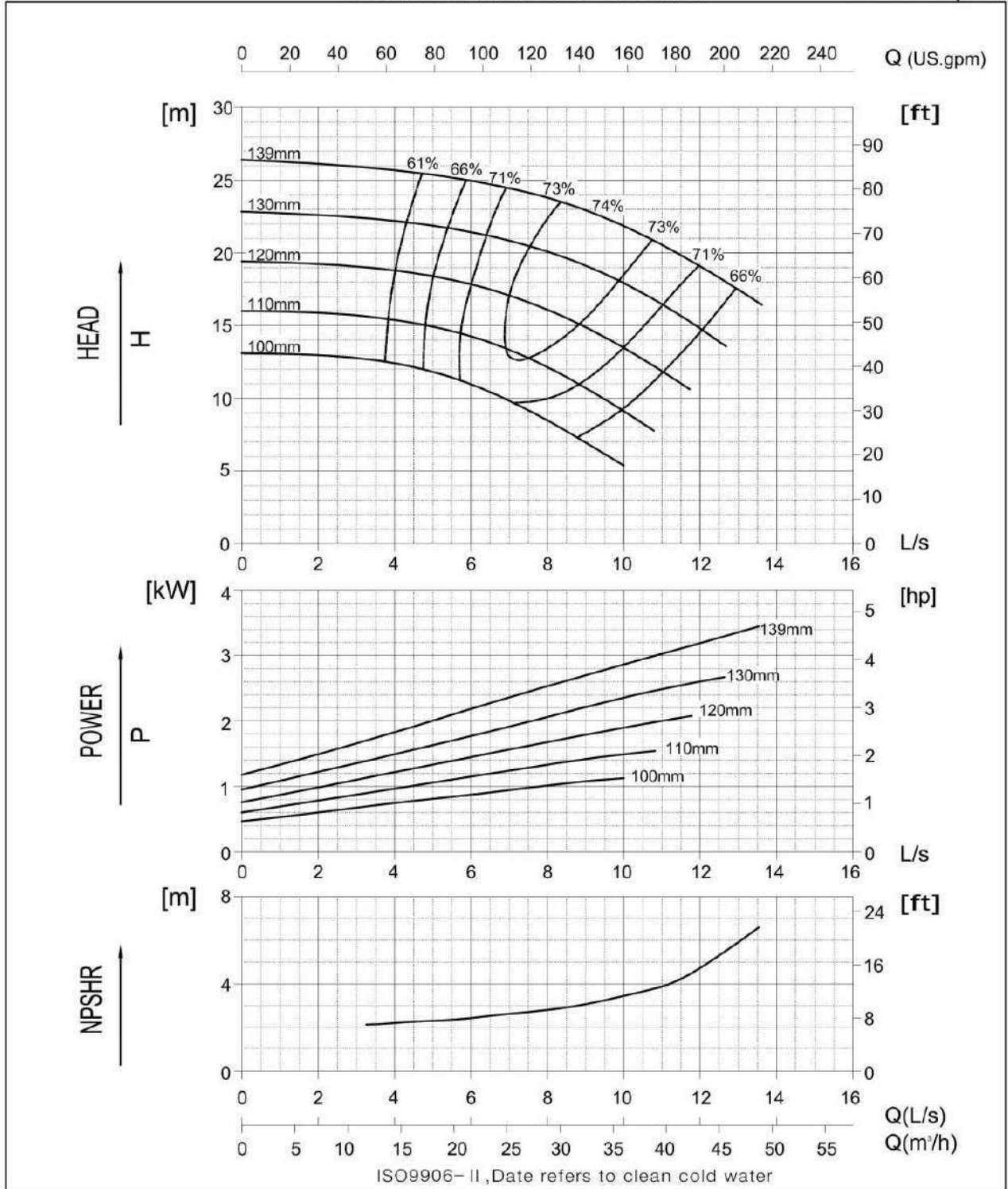

P1701A



BS EN 733/DIN 24255

65-40-160

Performance Curve

2900 rpm

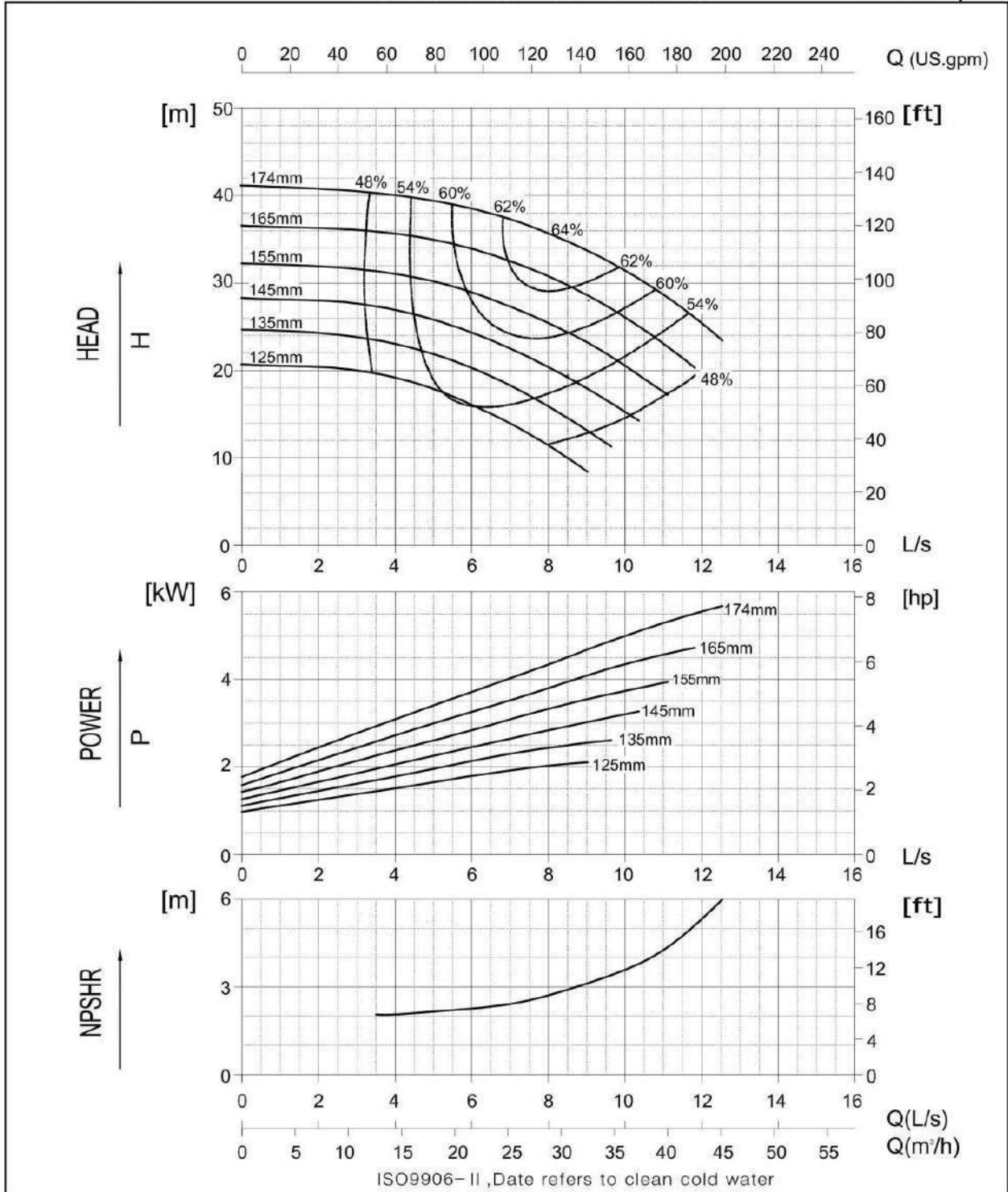

P1701A



BS EN 733/DIN 24255

65-40-200

### Performance Curve

2900 rpm

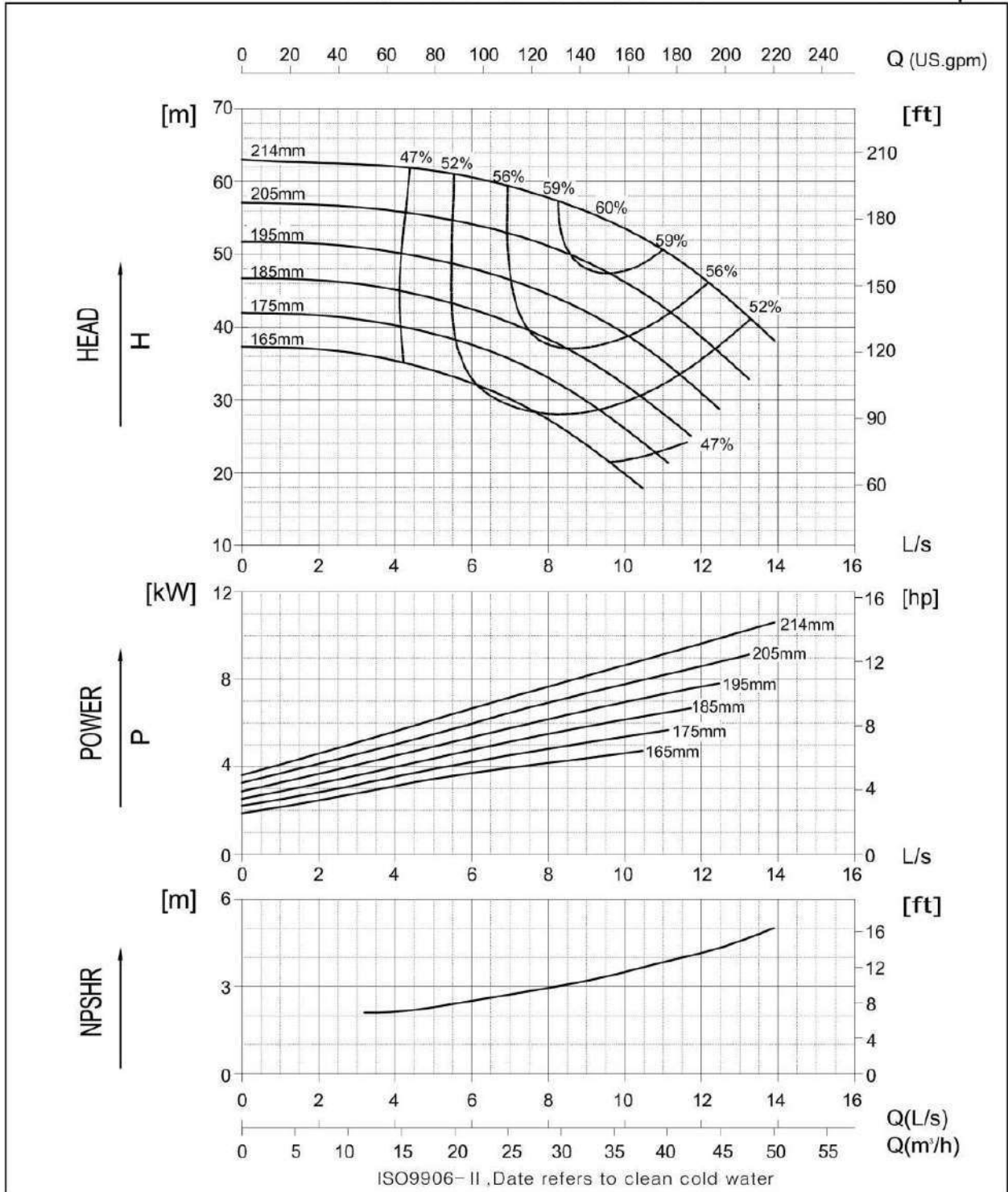

P1701A



BS EN 733/DIN 24255

65-40-260

Performance Curve

2900 rpm

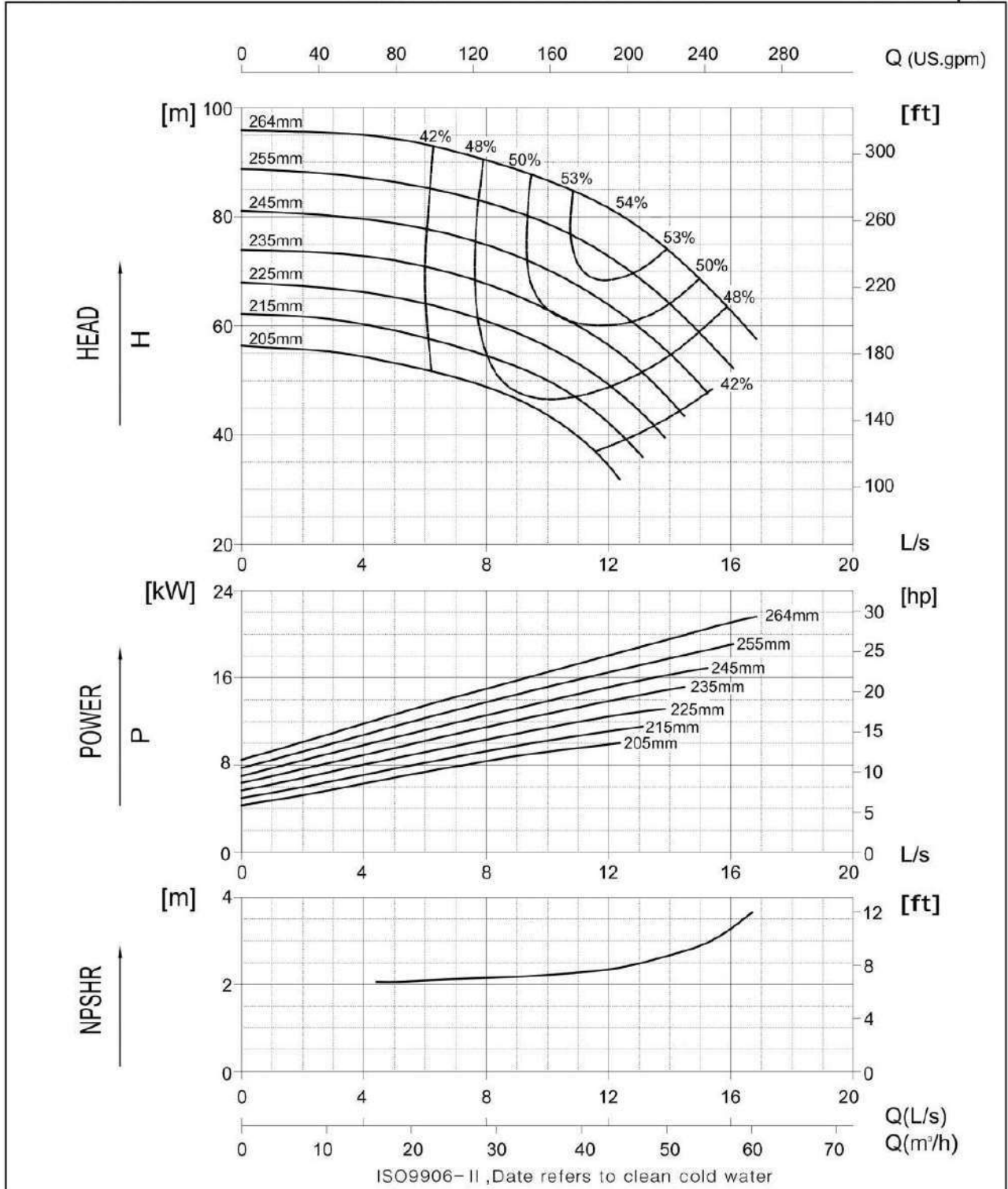

P1701A



BS EN 733/DIN 24255

65-40-320H

Performance Curve

2900 rpm

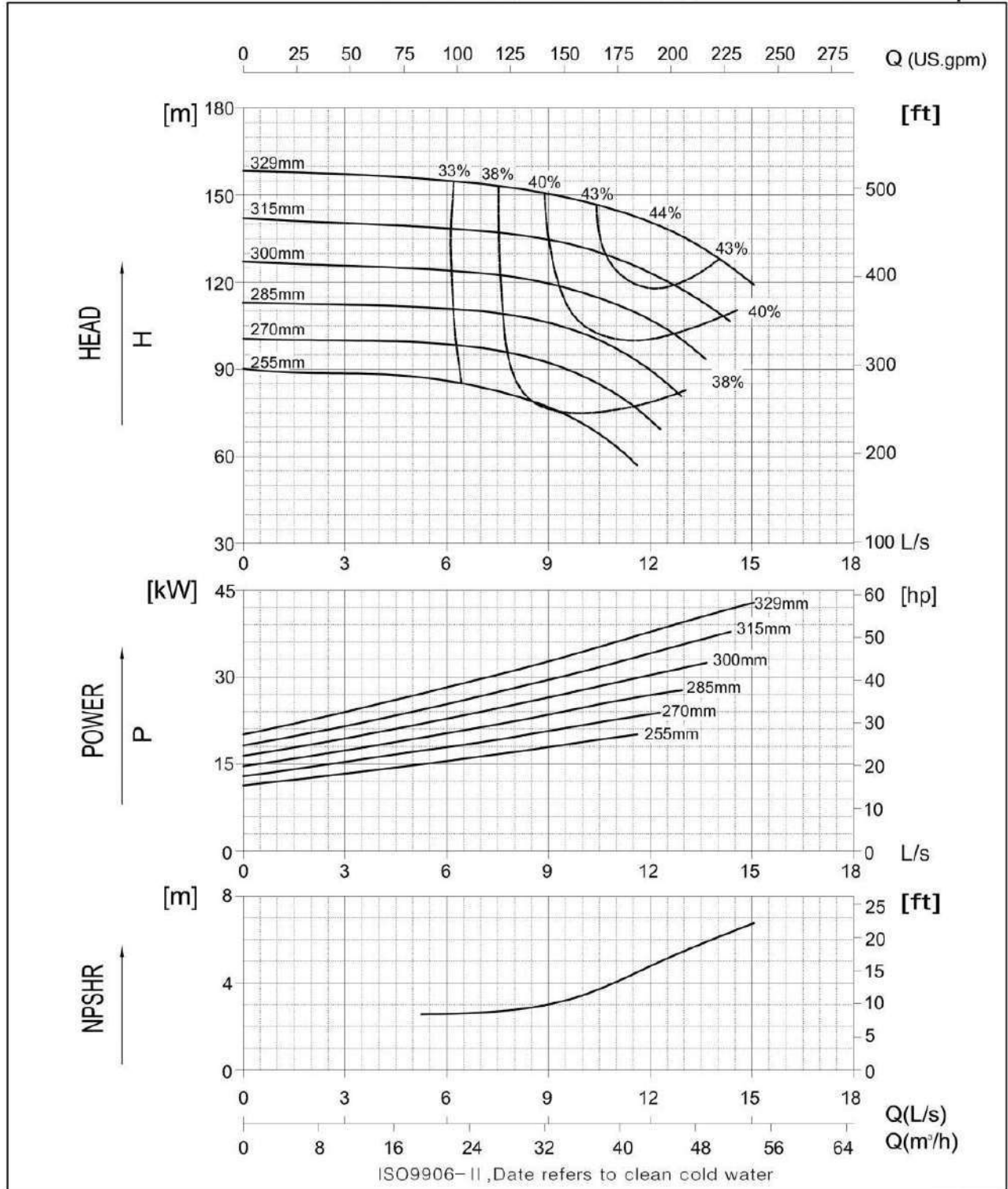

P1701A



BS EN 733/DIN 24255

65-50-130

Performance Curve

2900 rpm

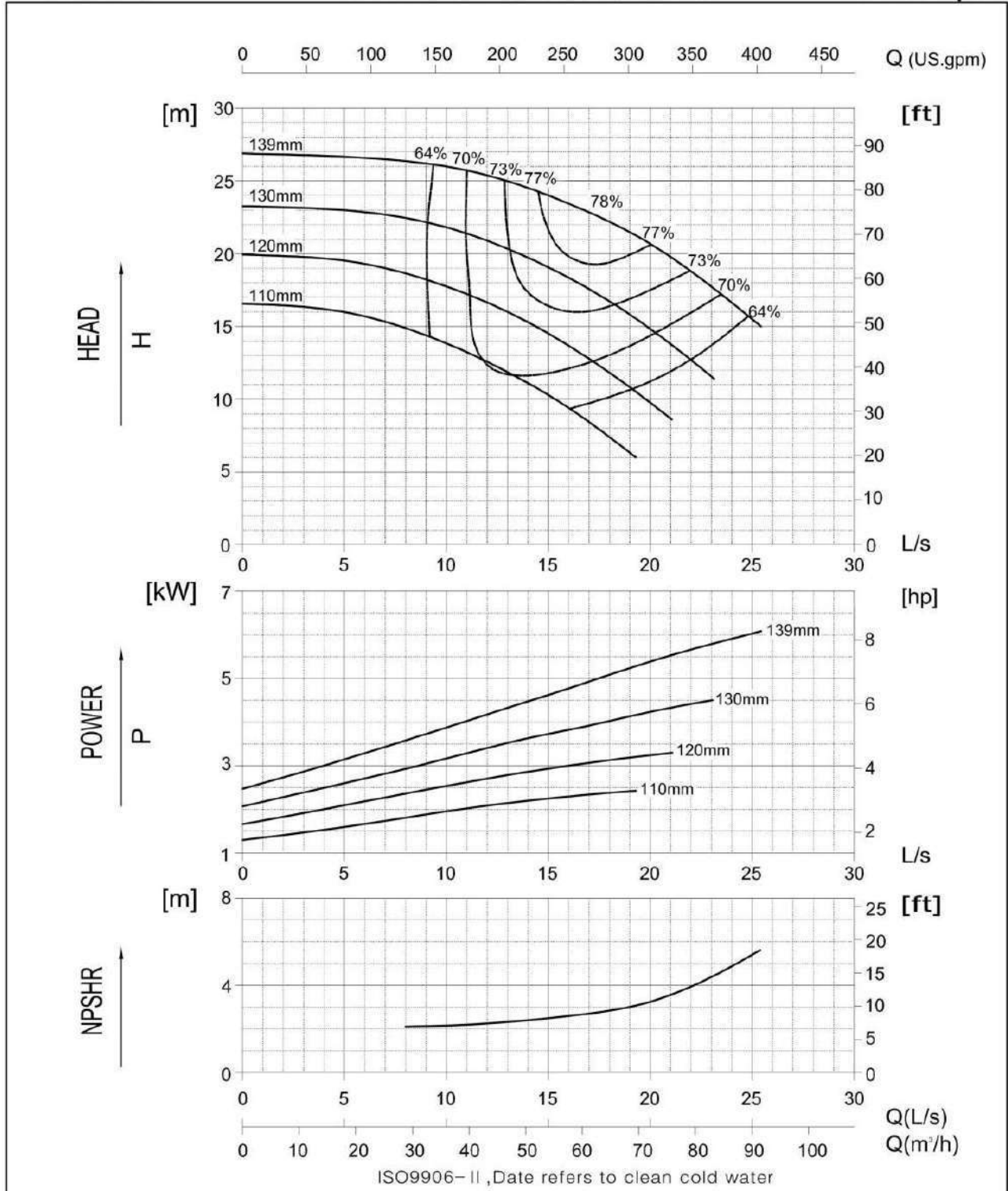

P1701A



BS EN 733/DIN 24255

65-50-160

Performance Curve

2900 rpm

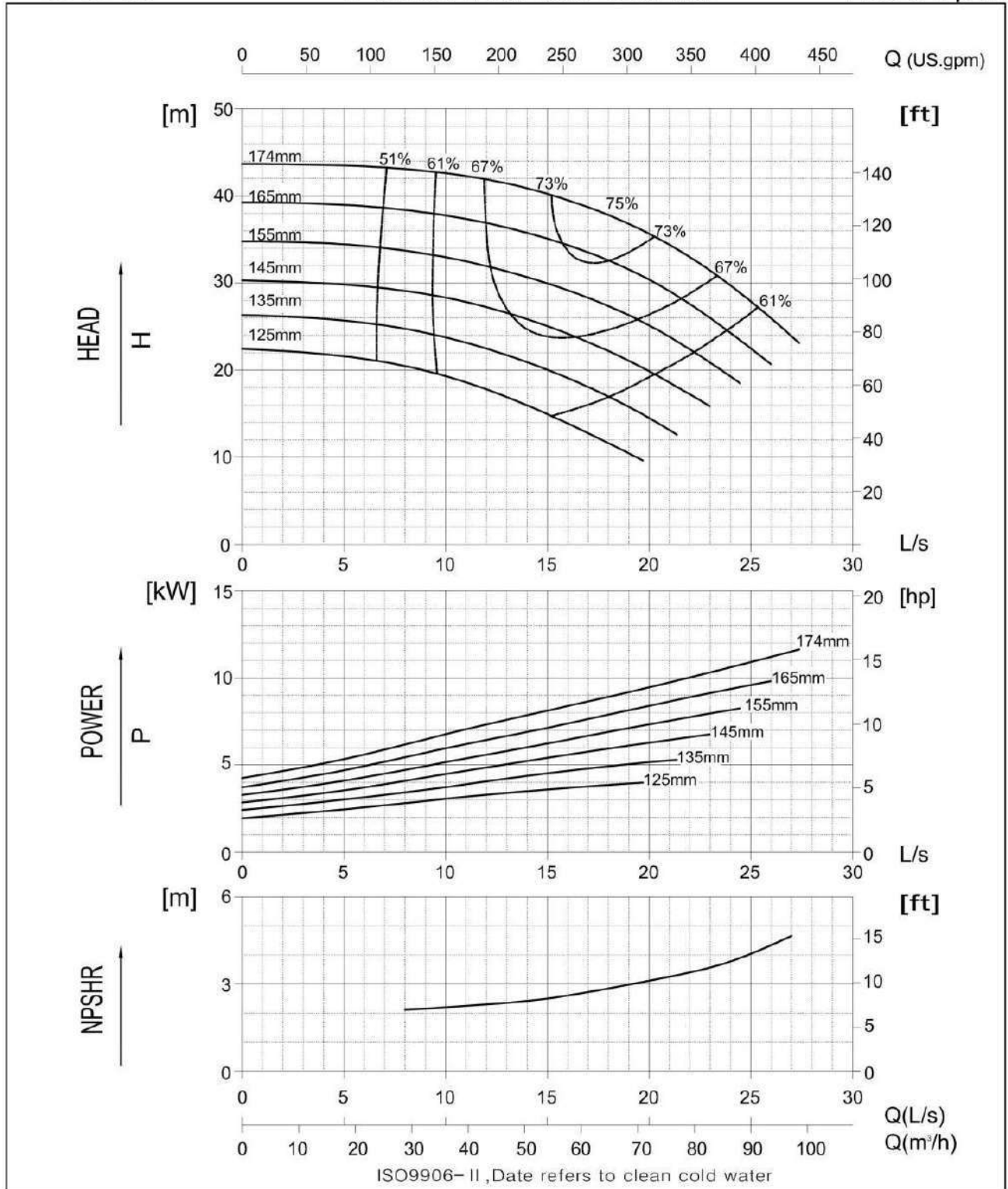

P1701A





BS EN 733/DIN 24255

65-50-200

Performance Curve

2900 rpm

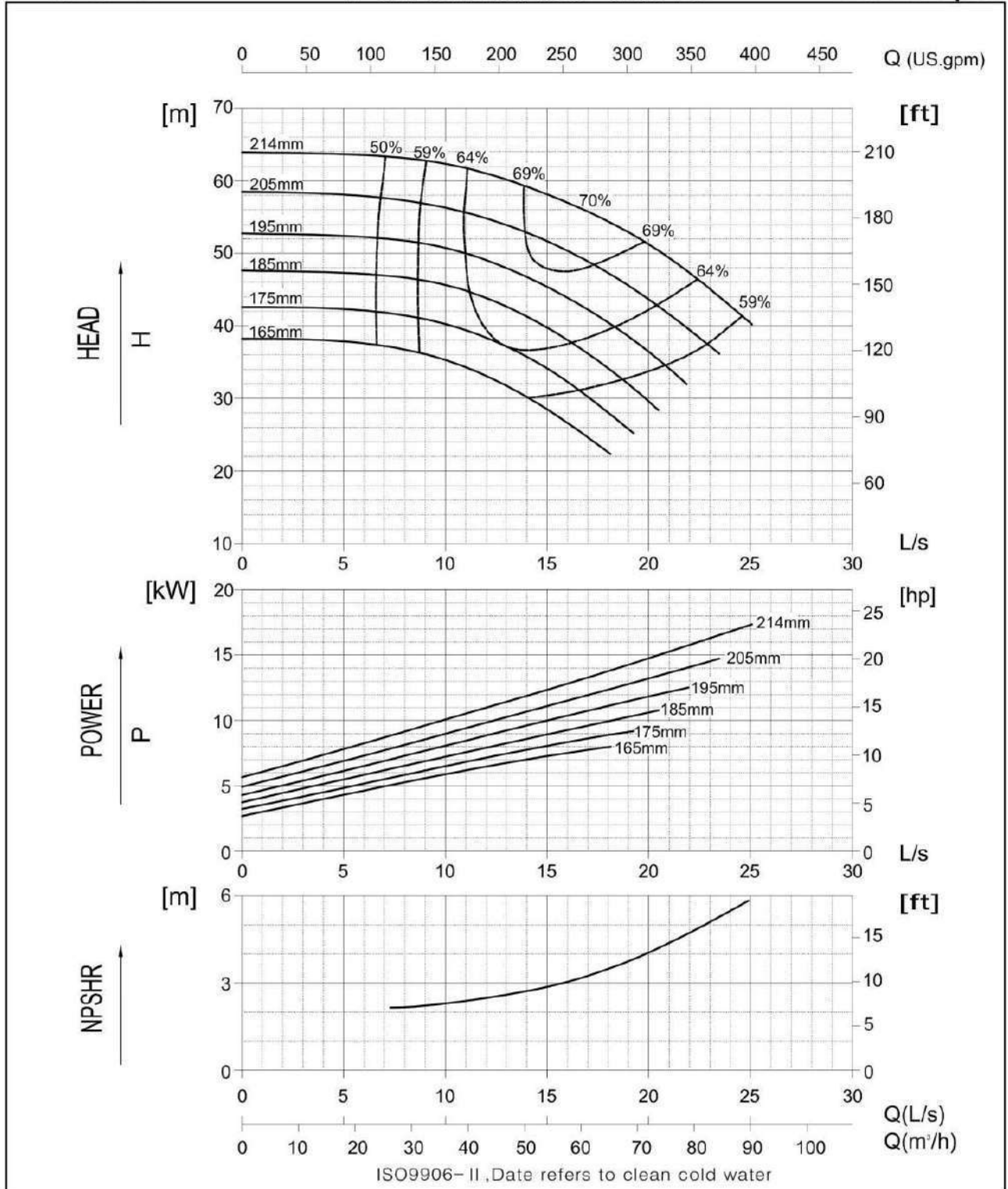

P1701A

BS EN 733/DIN 24255

65-50-260H

Performance Curve

2900 rpm

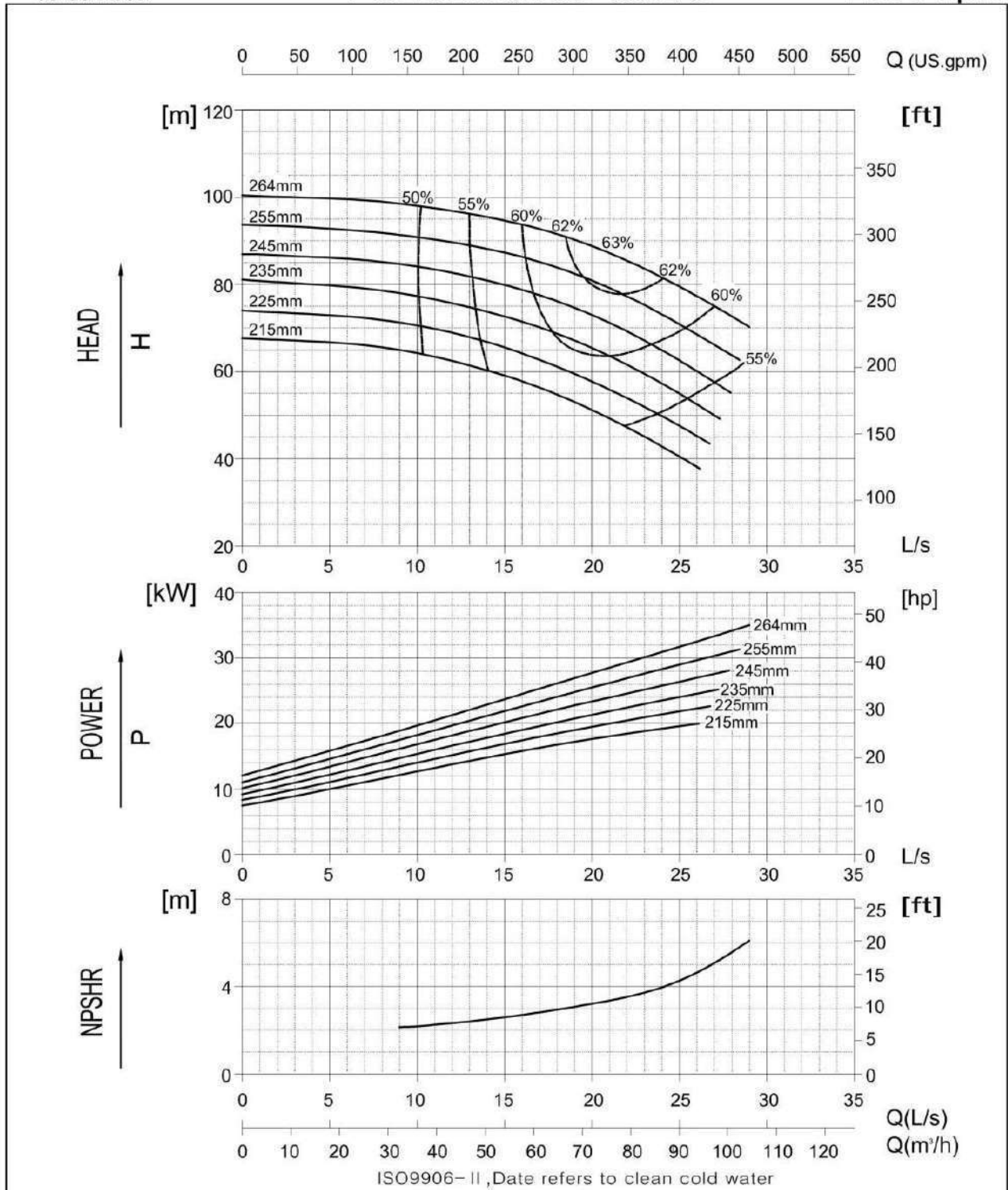

P1701A



BS EN 733/DIN 24255

65-50-320H

Performance Curve

2900 rpm

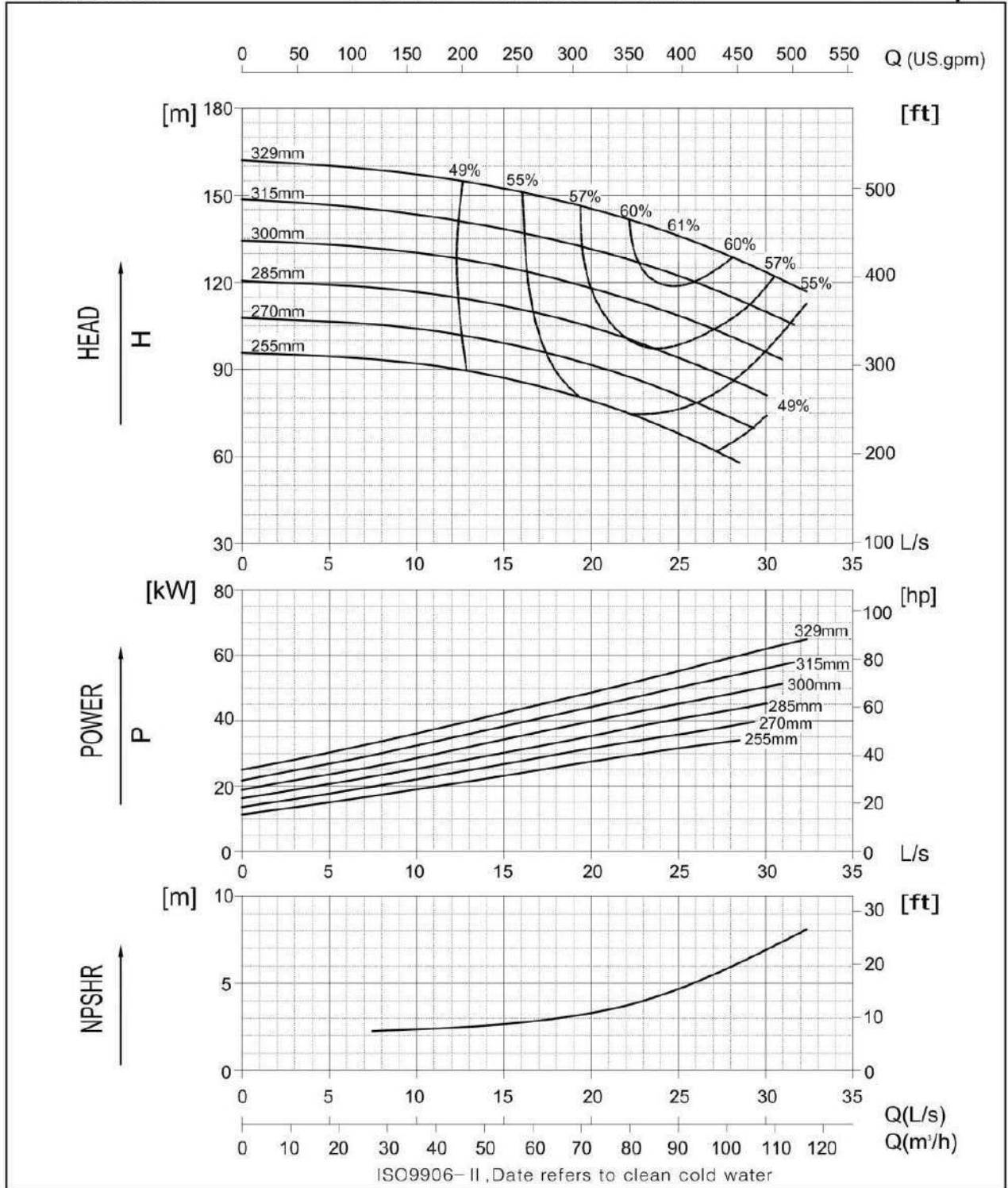

P1701A



BS EN 733/DIN 24255

80-65-130

Performance Curve

2900 rpm

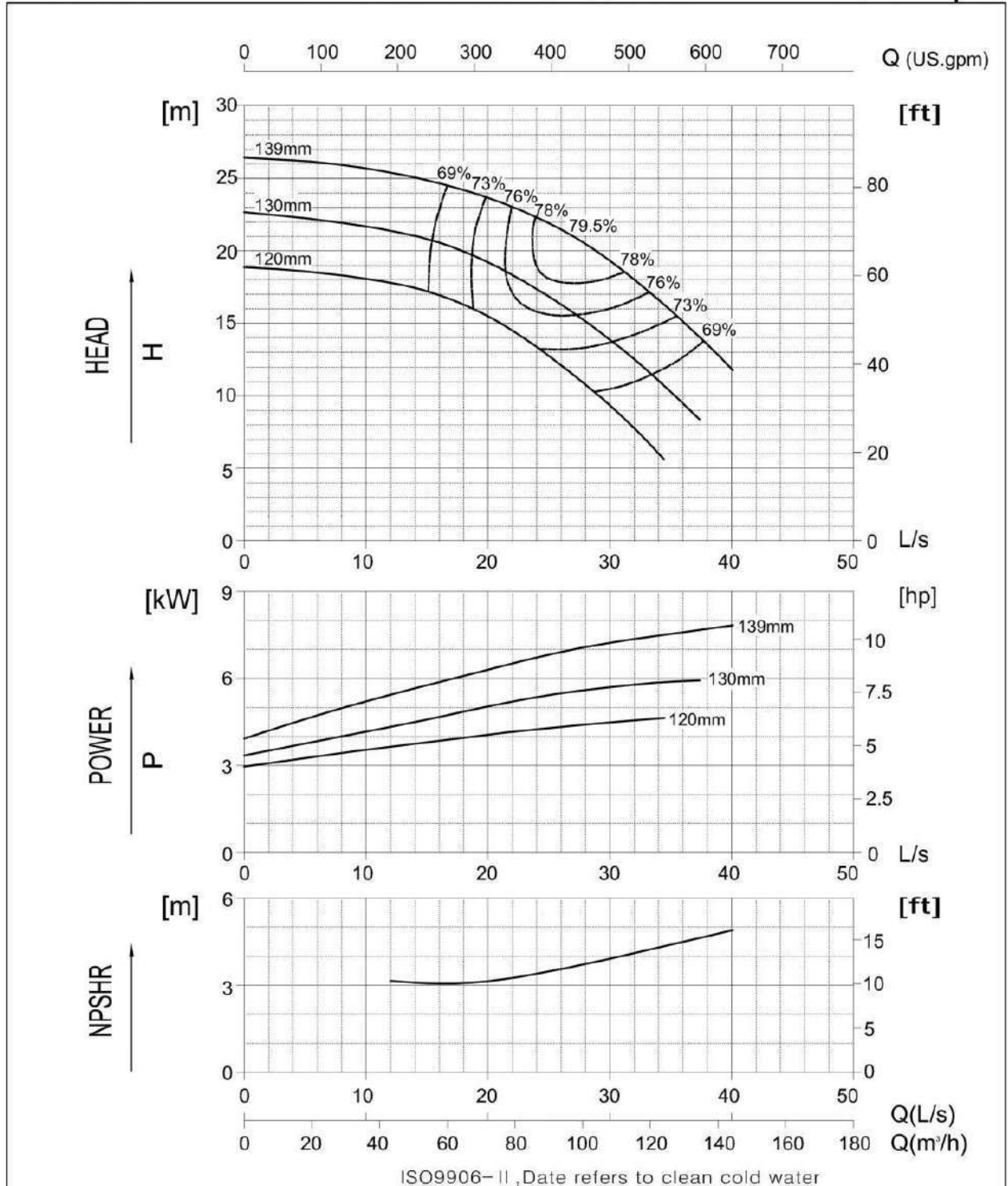

ISO9906-II, Date refers to clean cold water

P1701A



BS EN 733/DIN 24255

80-65-160

Performance Curve

2900 rpm

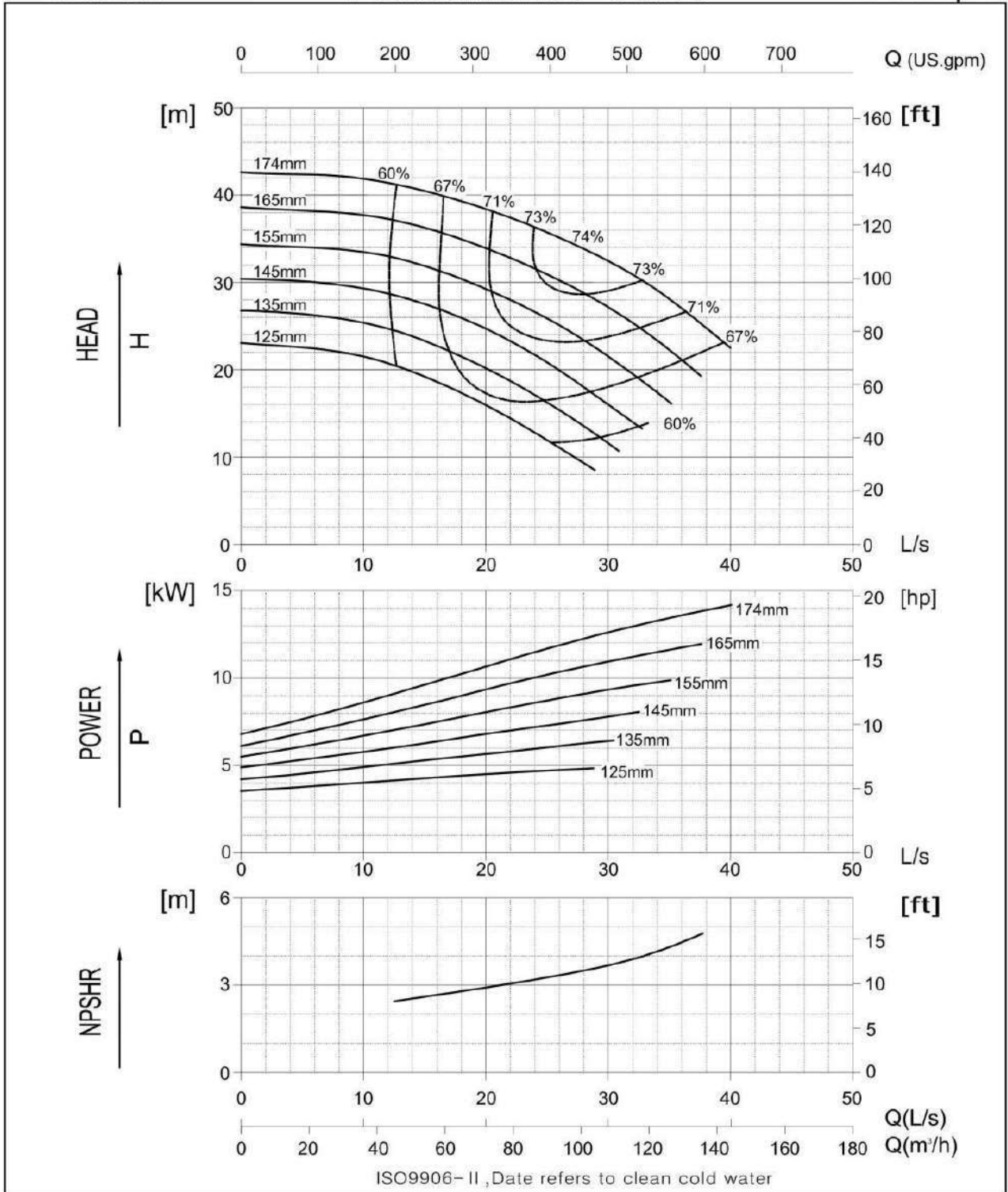

P1701A



BS EN 733/DIN 24255

80-65-200H

Performance Curve

2900 rpm

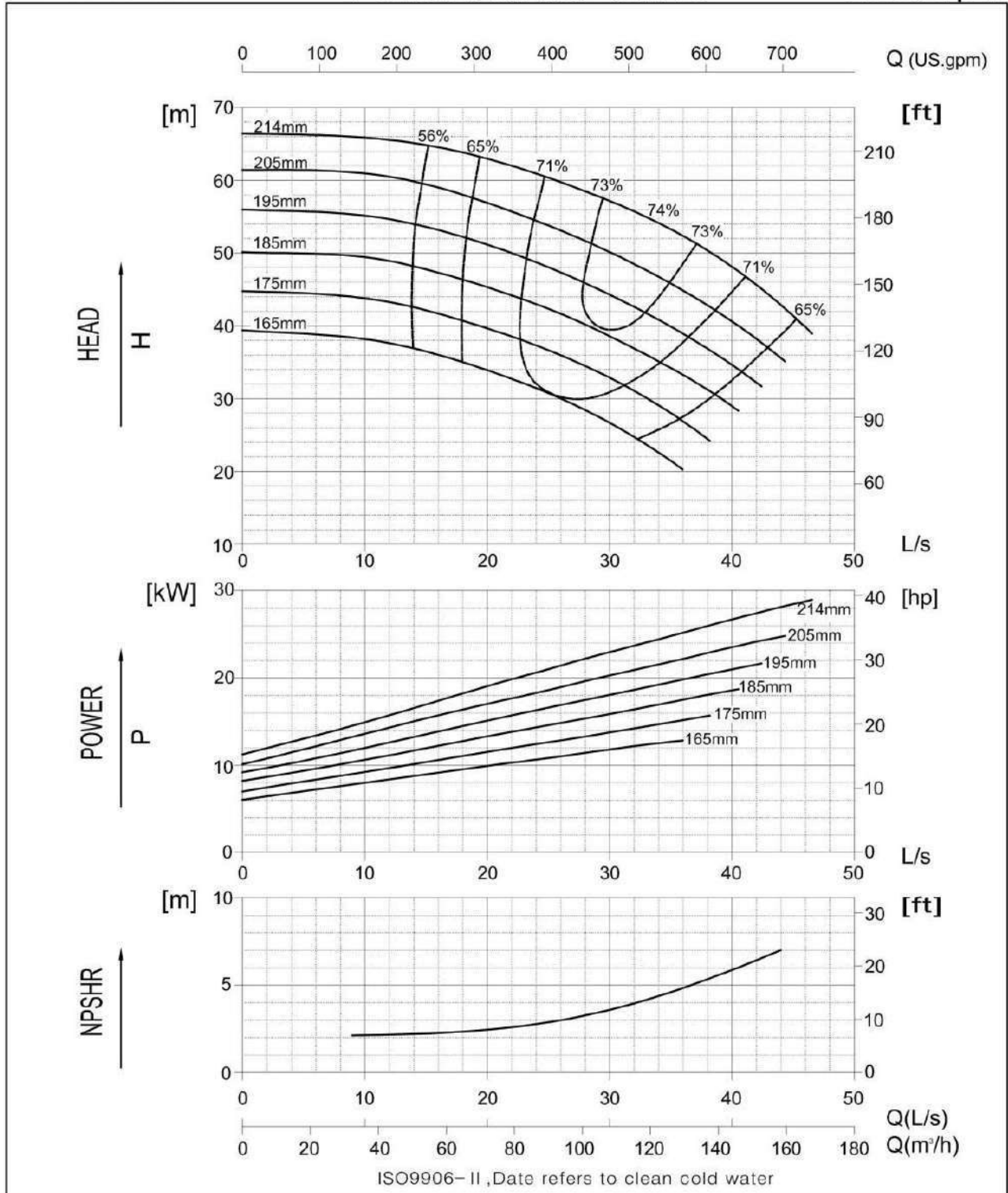

P1701A



BS EN 733/DIN 24255

80-65-260

Performance Curve

2900 rpm

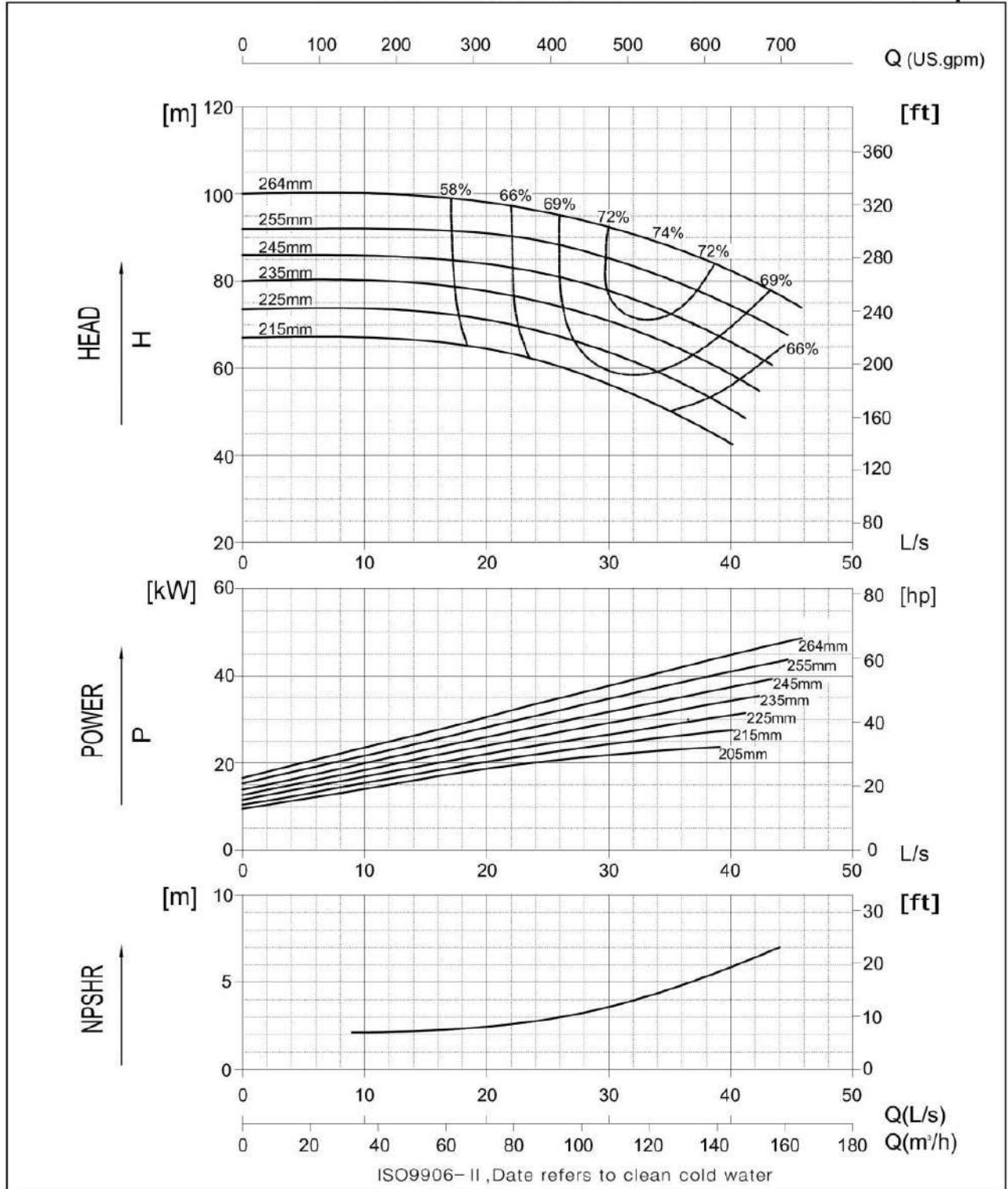

P1701A



BS EN 733/DIN 24255

80-65-320H

Performance Curve

2900 rpm

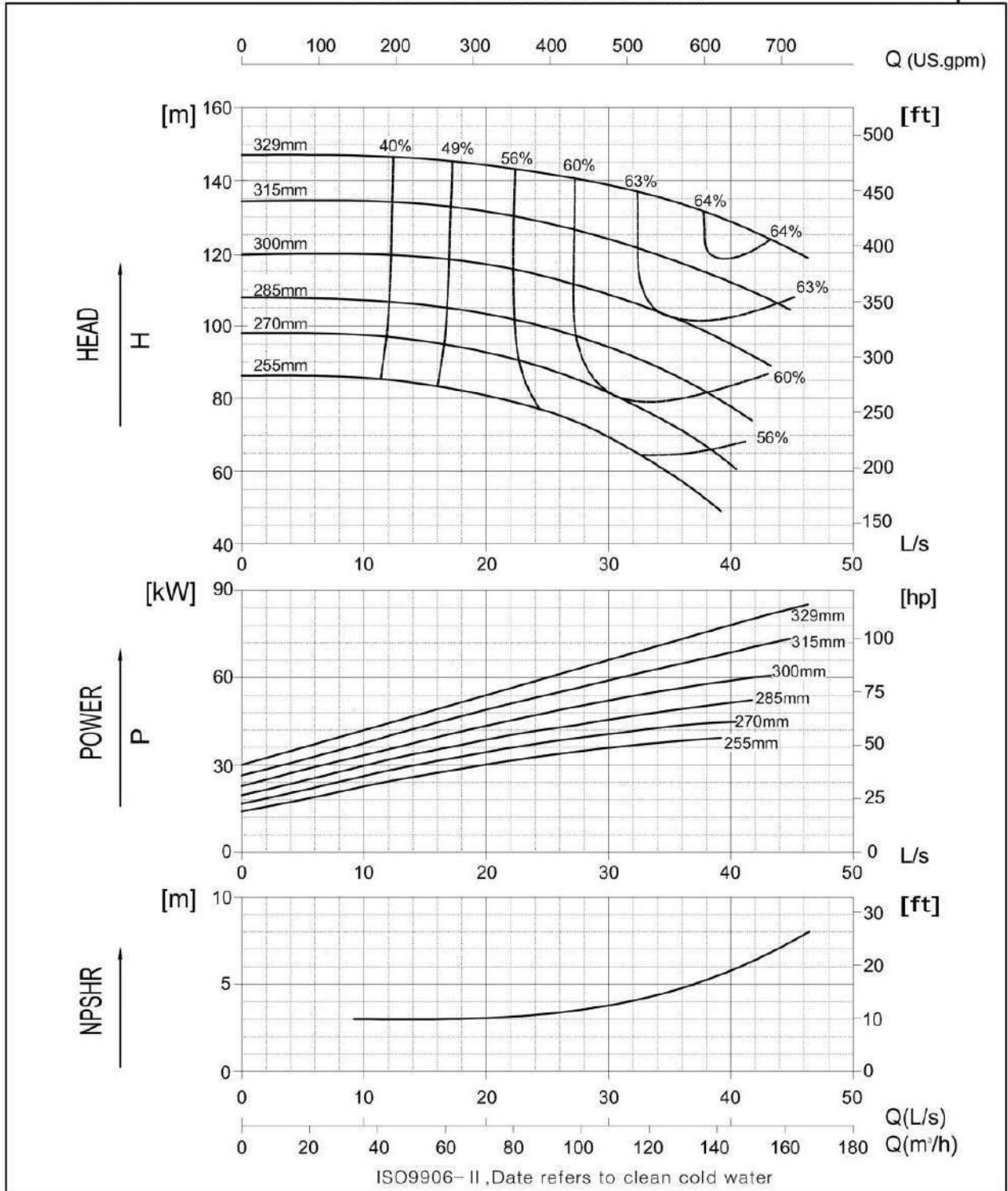

P1701A





BS EN 733/DIN 24255

100-80-160

### Performance Curve

2900 rpm

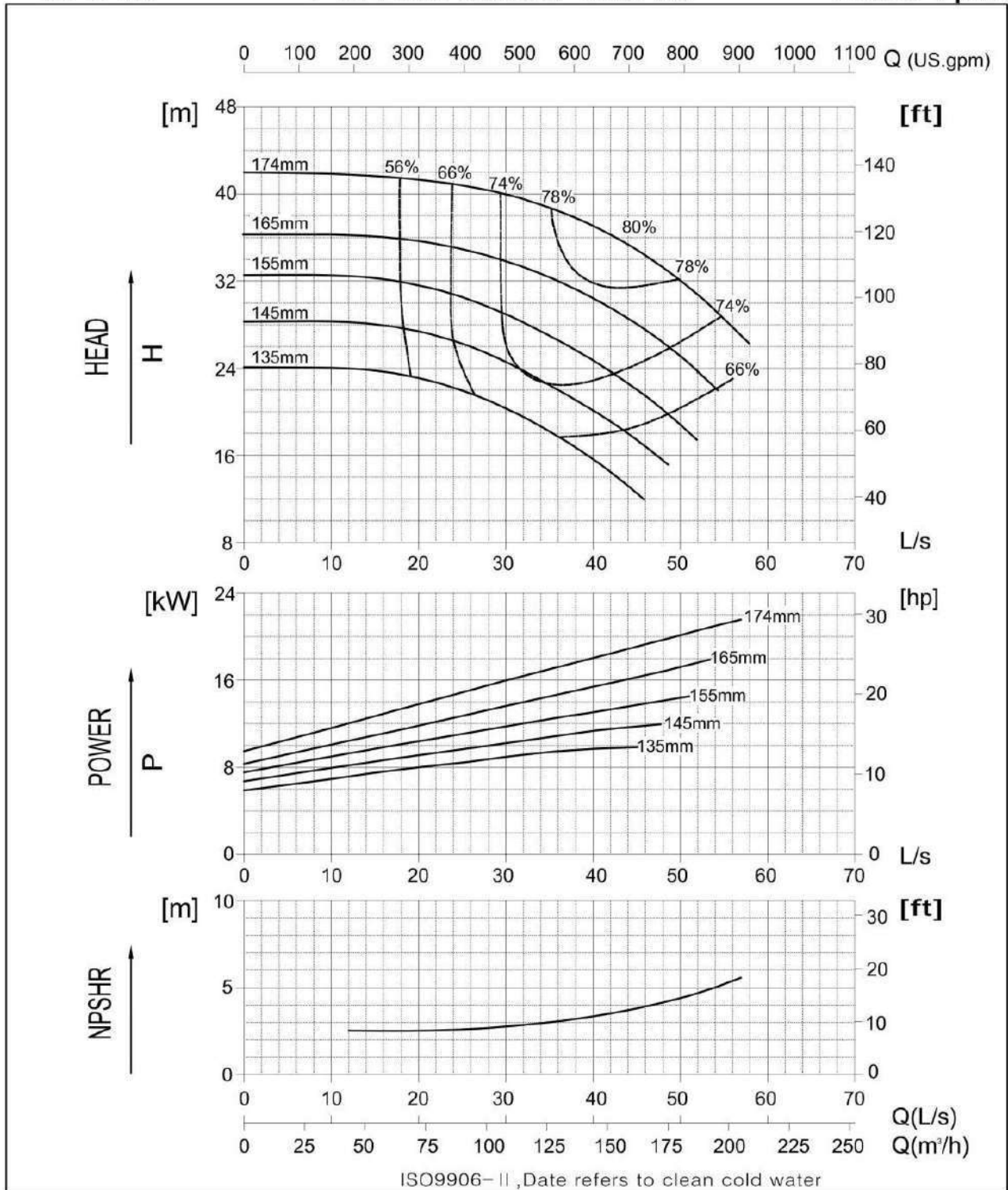

ISO9906-II, Date refers to clean cold water

P1701A



BS EN 733/DIN 24255

100-80-200

Performance Curve

2900 rpm

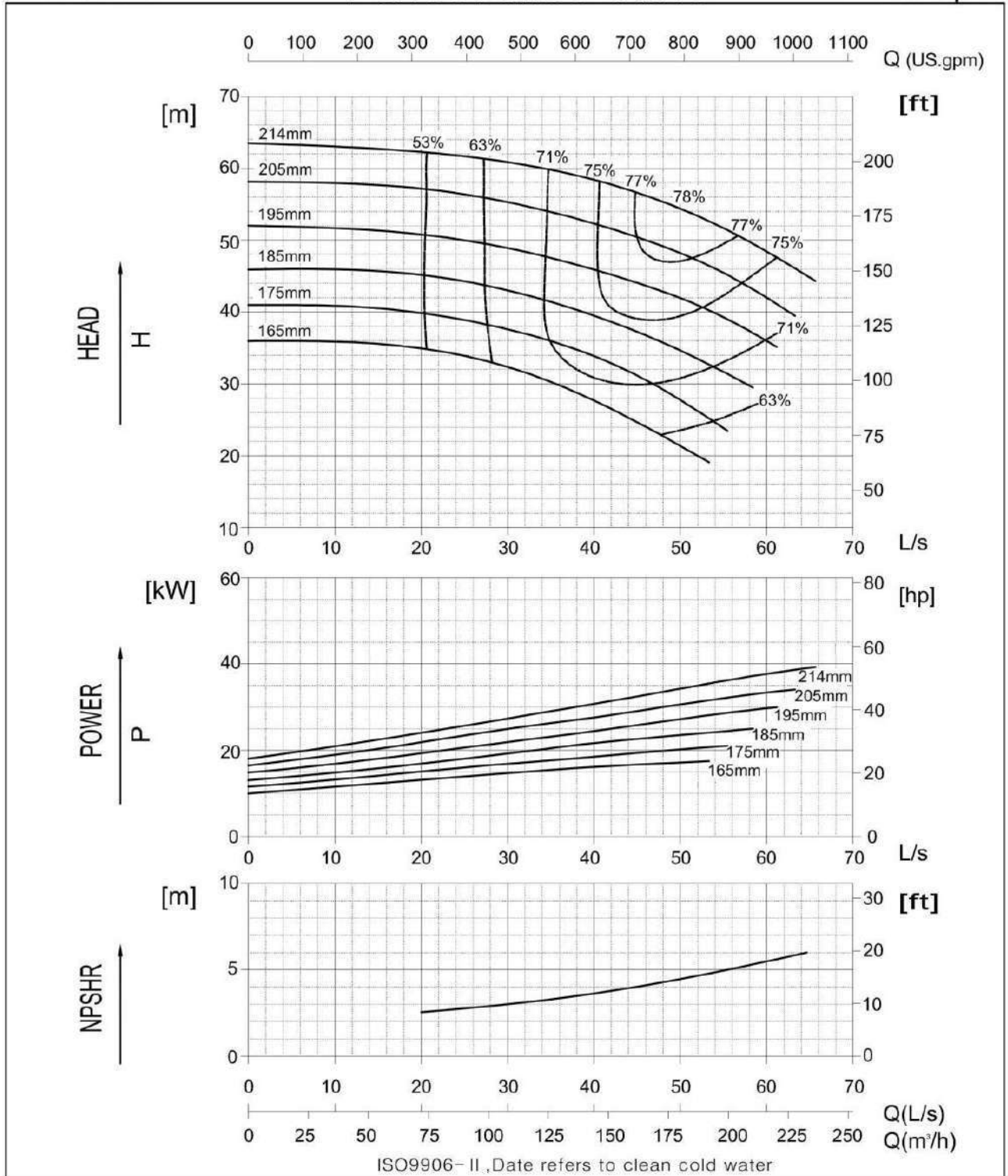

P1701A



BS EN 733/DIN 24255

100-80-260

Performance Curve

2900 rpm

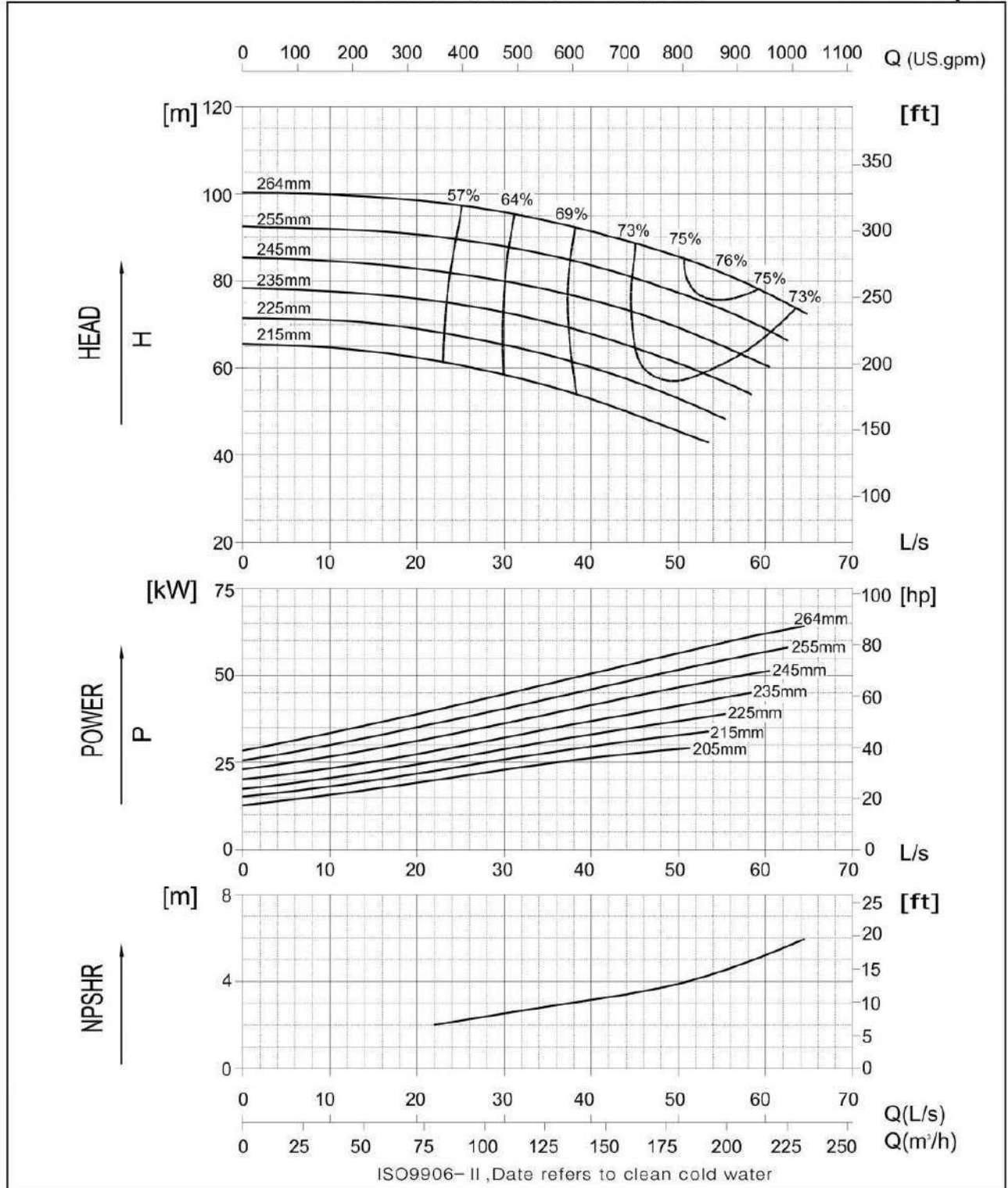

P1701A



BS EN 733/DIN 24255

100-80-320H

Performance Curve

2900 rpm

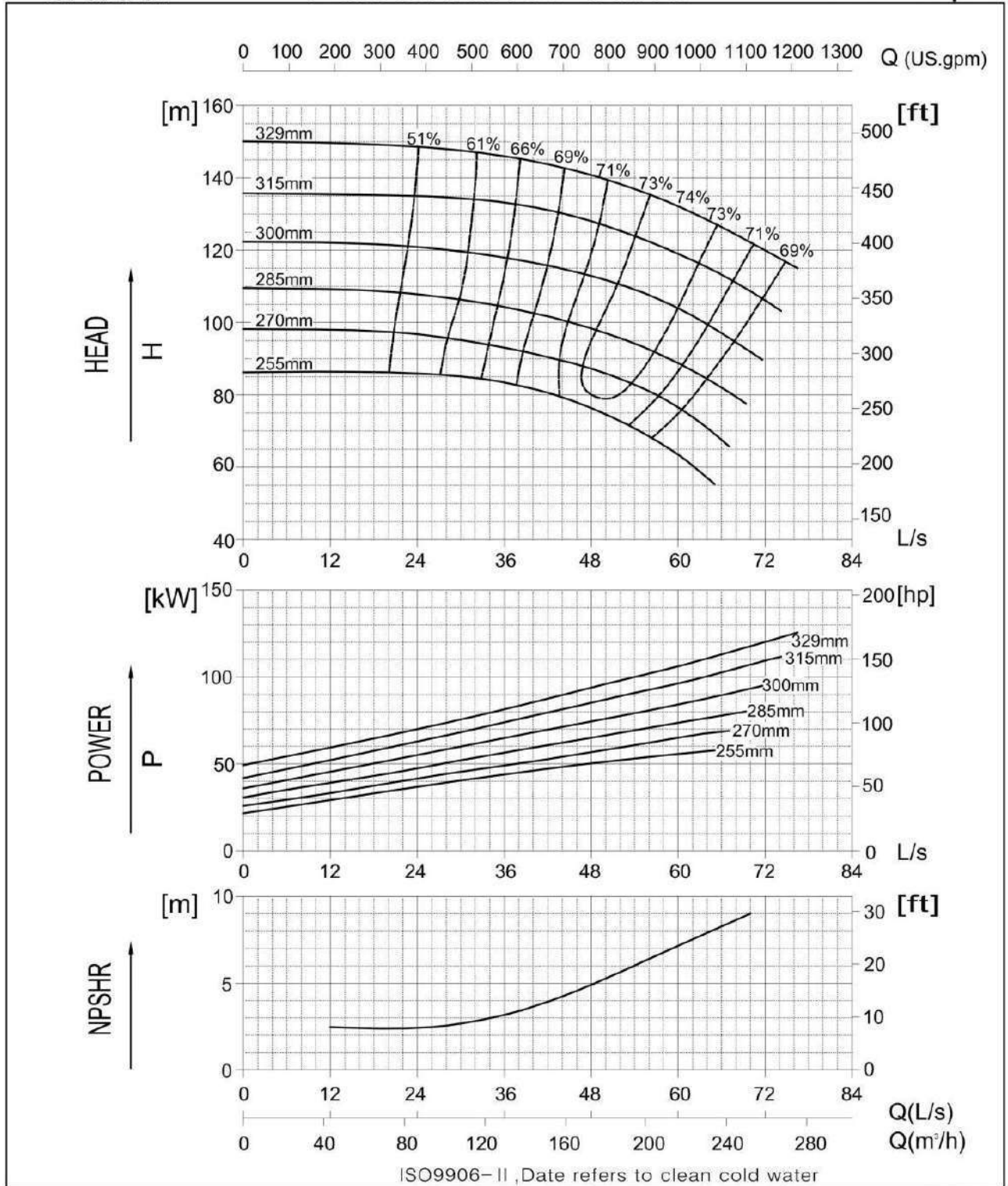

P1701A



BS EN 733/DIN 24255

125-100-160

### Performance Curve

2900 rpm

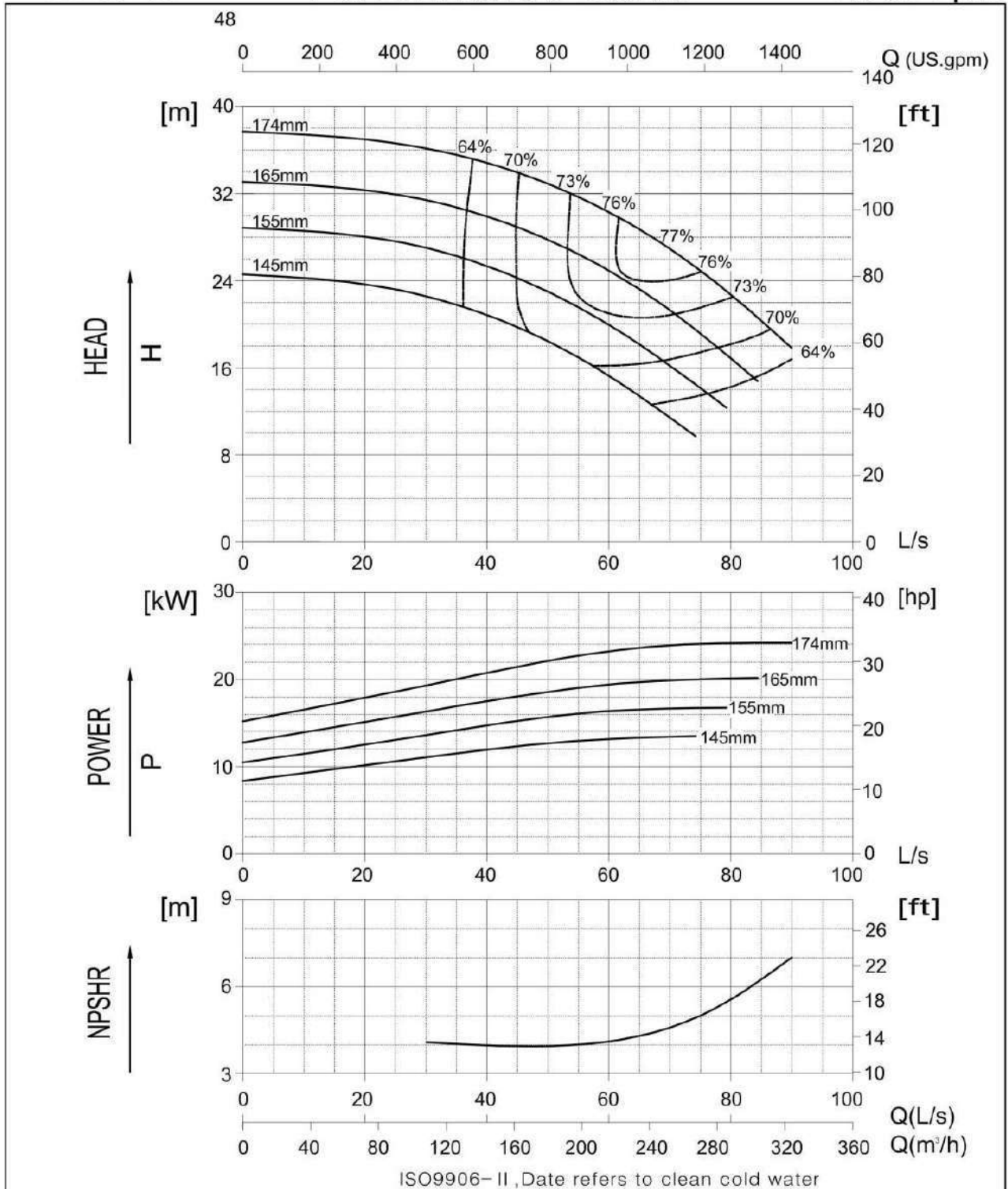

ISO9906-II, Date refers to clean cold water

P1701A



BS EN 733/DIN 24255

125-100-200

Performance Curve

2900 rpm

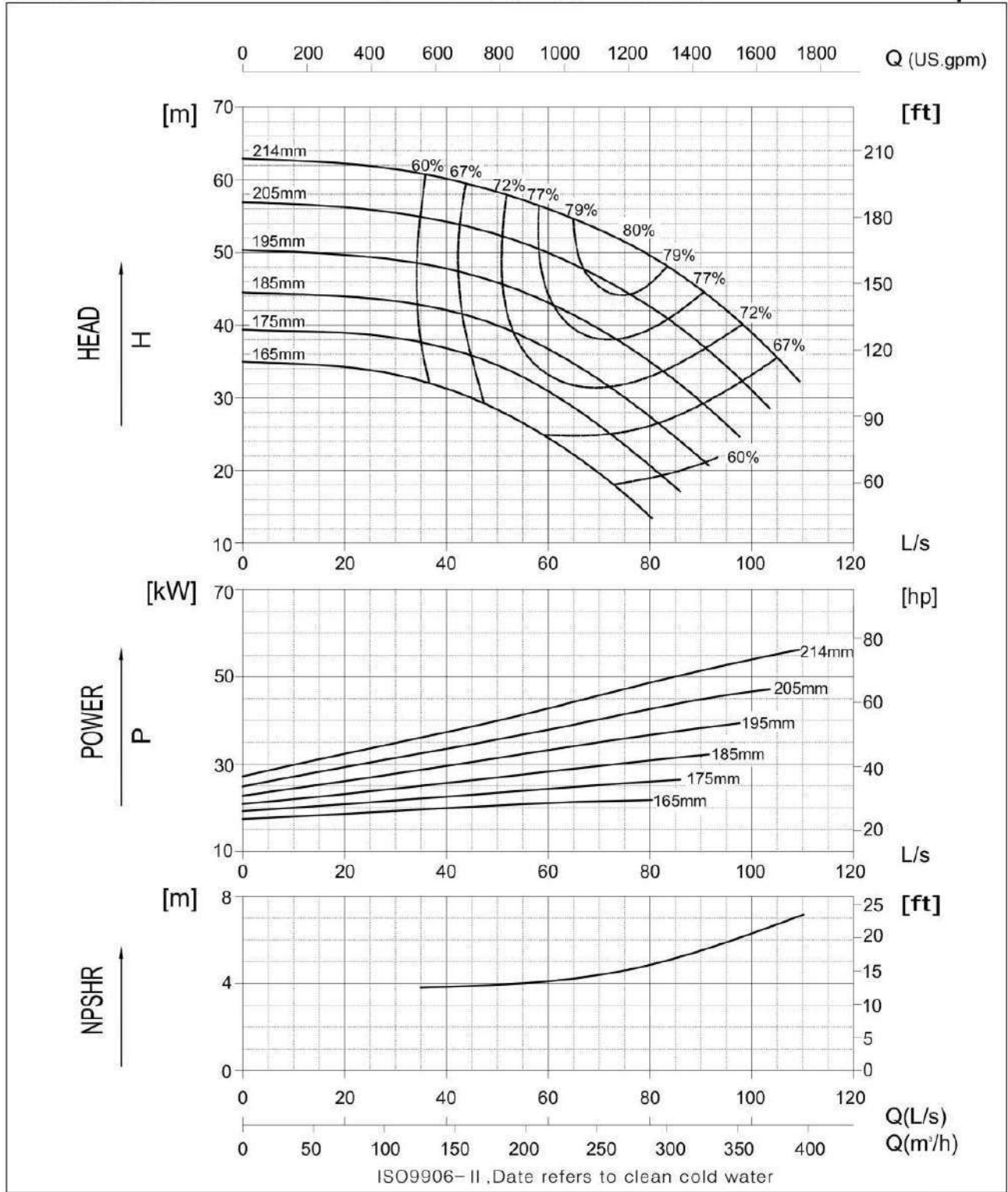

P1701A



BS EN 733/DIN 24255

125-100-260H

Performance Curve

2900 rpm

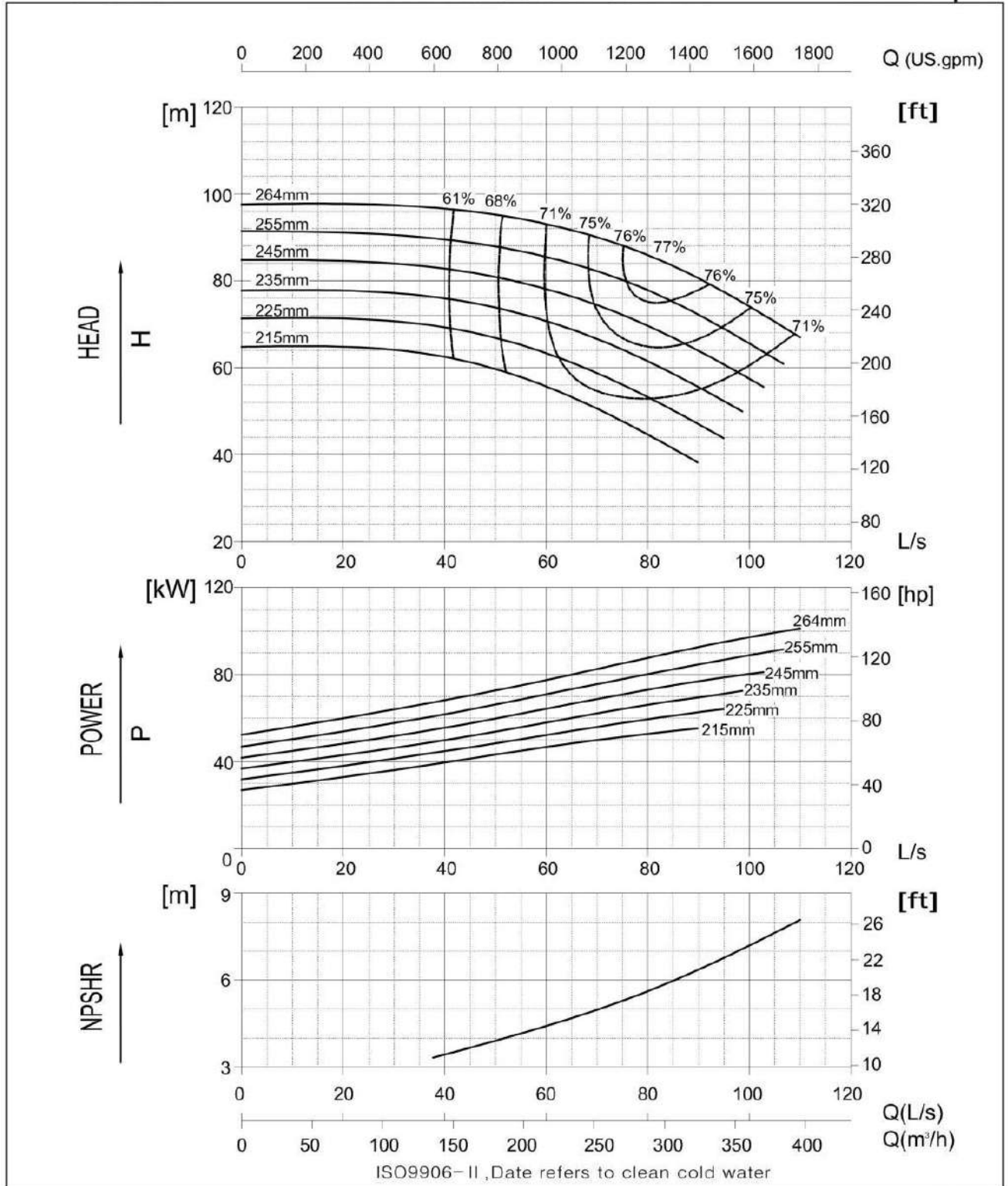

P1701A



BS EN 733/DIN 24255

125-100-320H

Performance Curve

2900 rpm

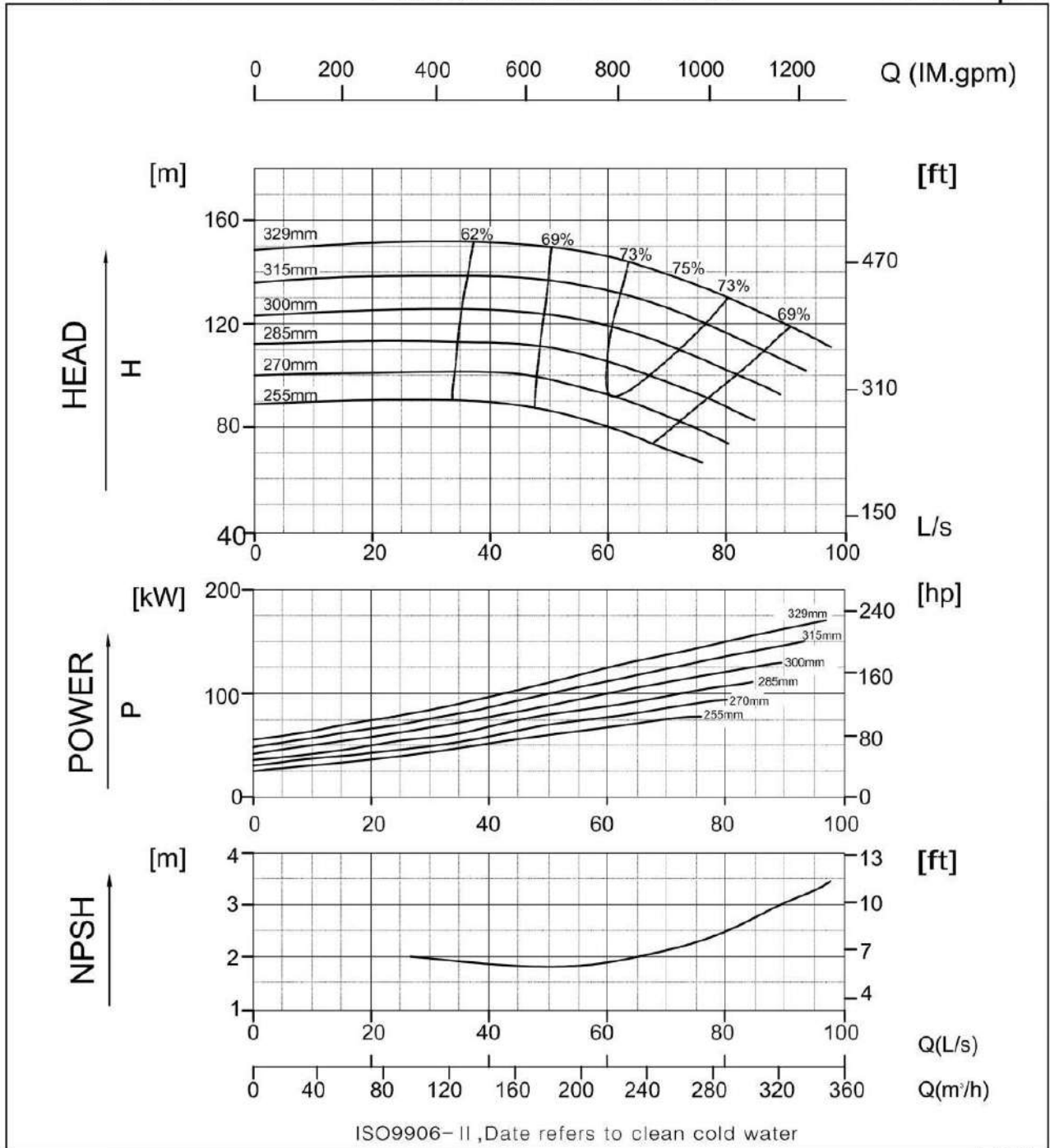

P1701A



BS EN 733/DIN 24255

150-125-200

Performance Curve

2900 rpm

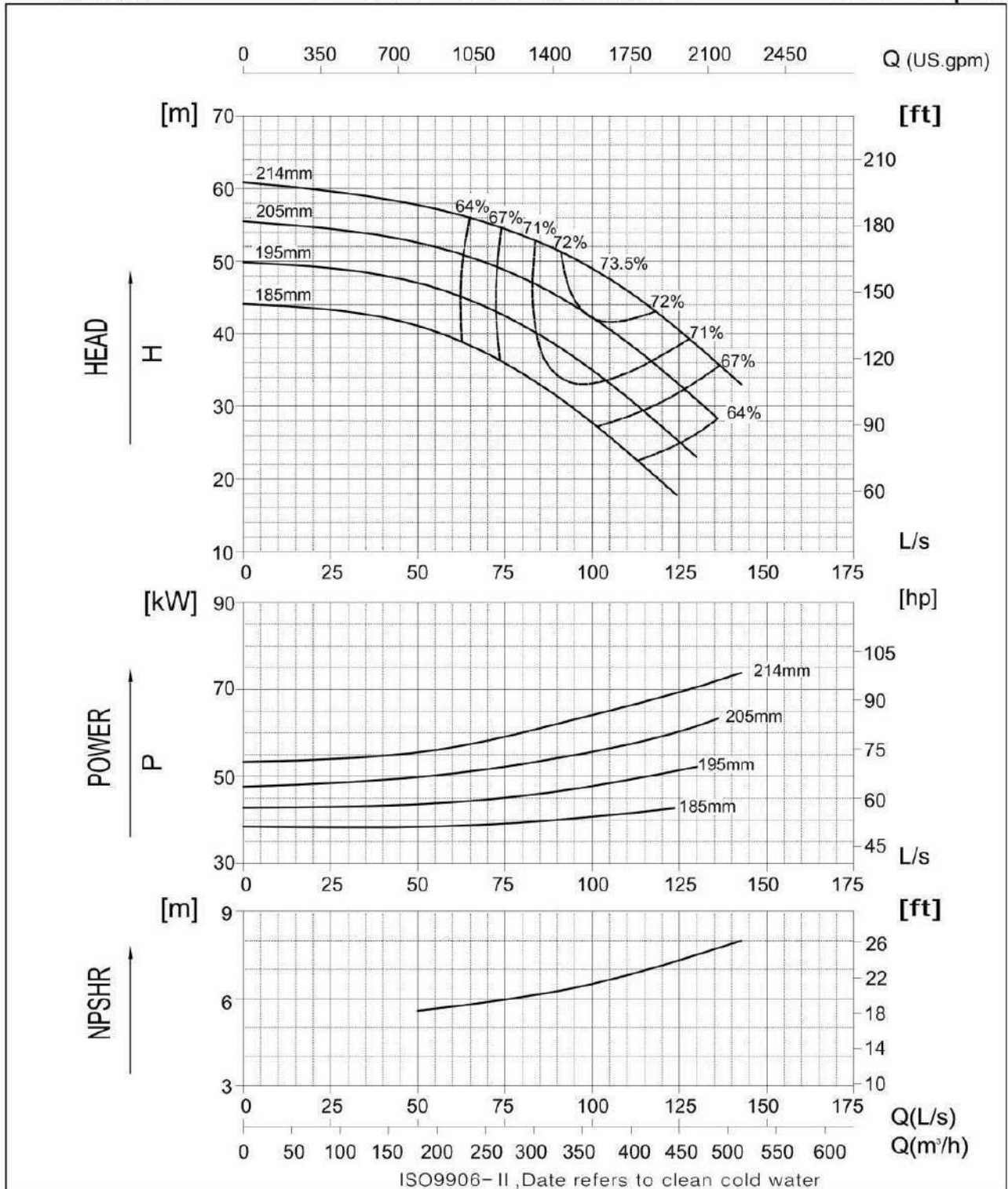

P1701A



Windows DDE Object

BS EN 733/DIN 24255

### 150-125-260H Performance Curve 2900 rpm

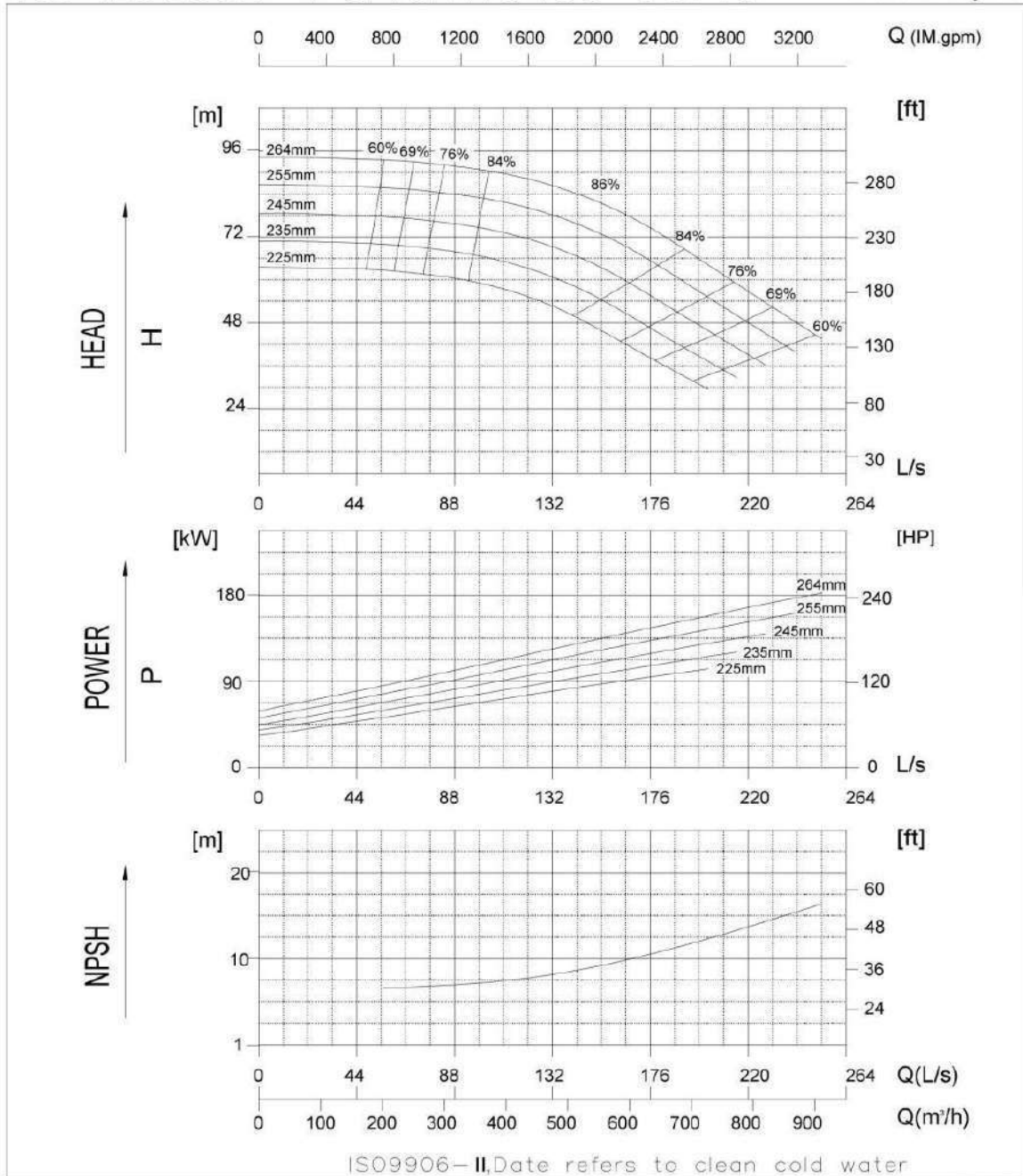

ISO9906-II, Date refers to clean cold water

P1701A



BS EN 733/DIN 24255

50-32-130

Performance Curve

1450 rpm

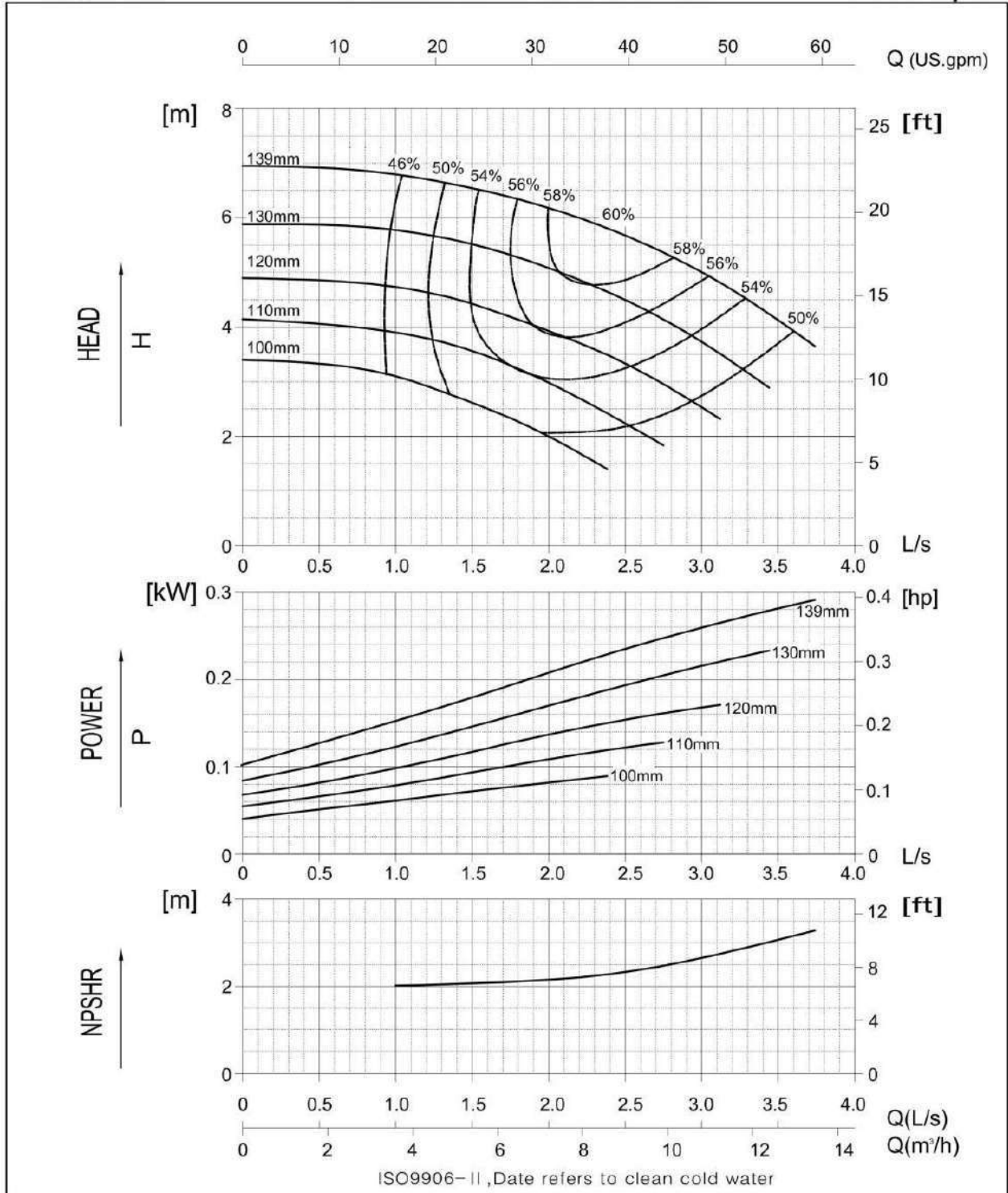

P1701A



BS EN 733/DIN 24255

50-32-160

Performance Curve

1450 rpm

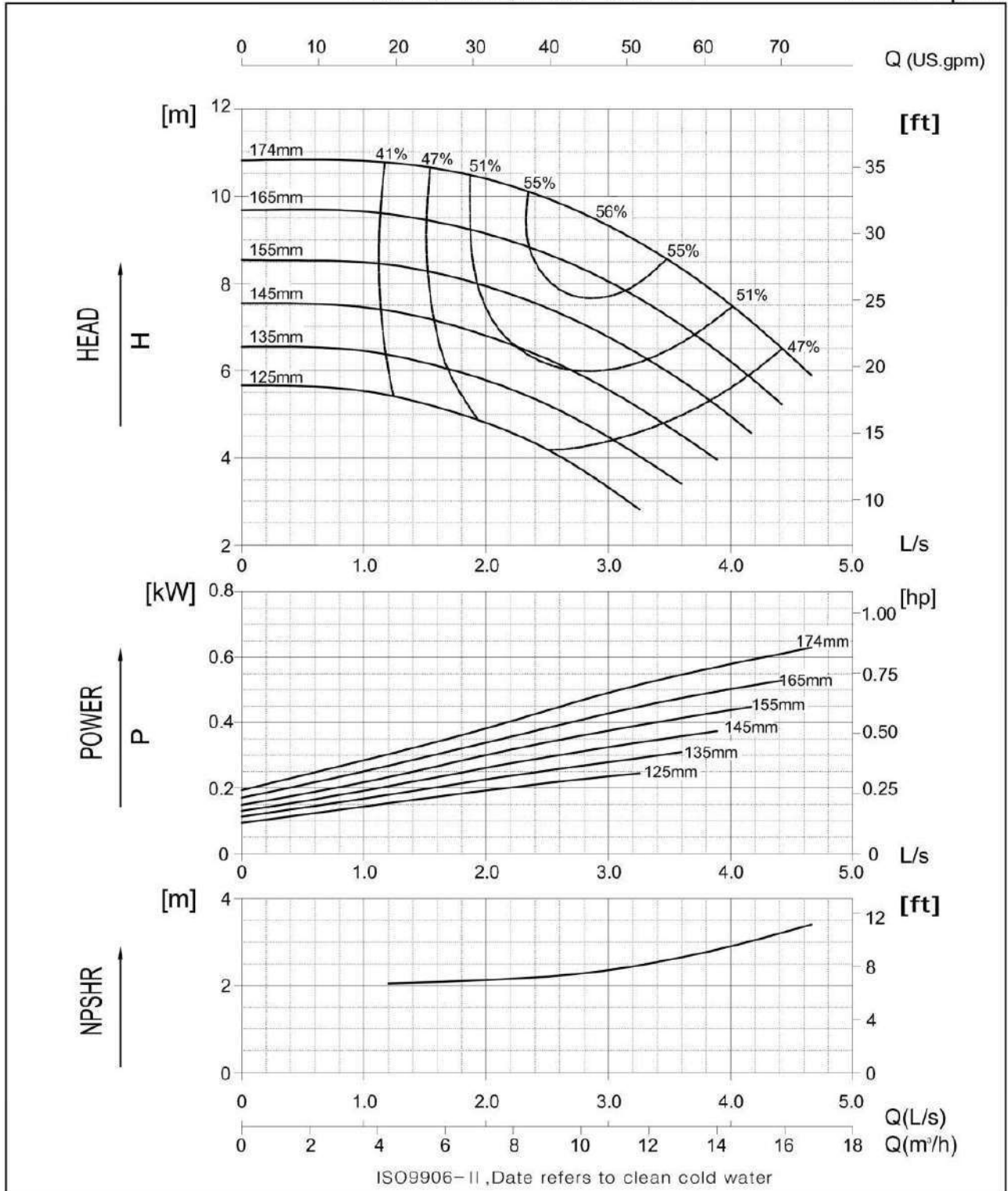

P1701A

BS EN 733/DIN 24255

50-32-200

Performance Curve

1450 rpm

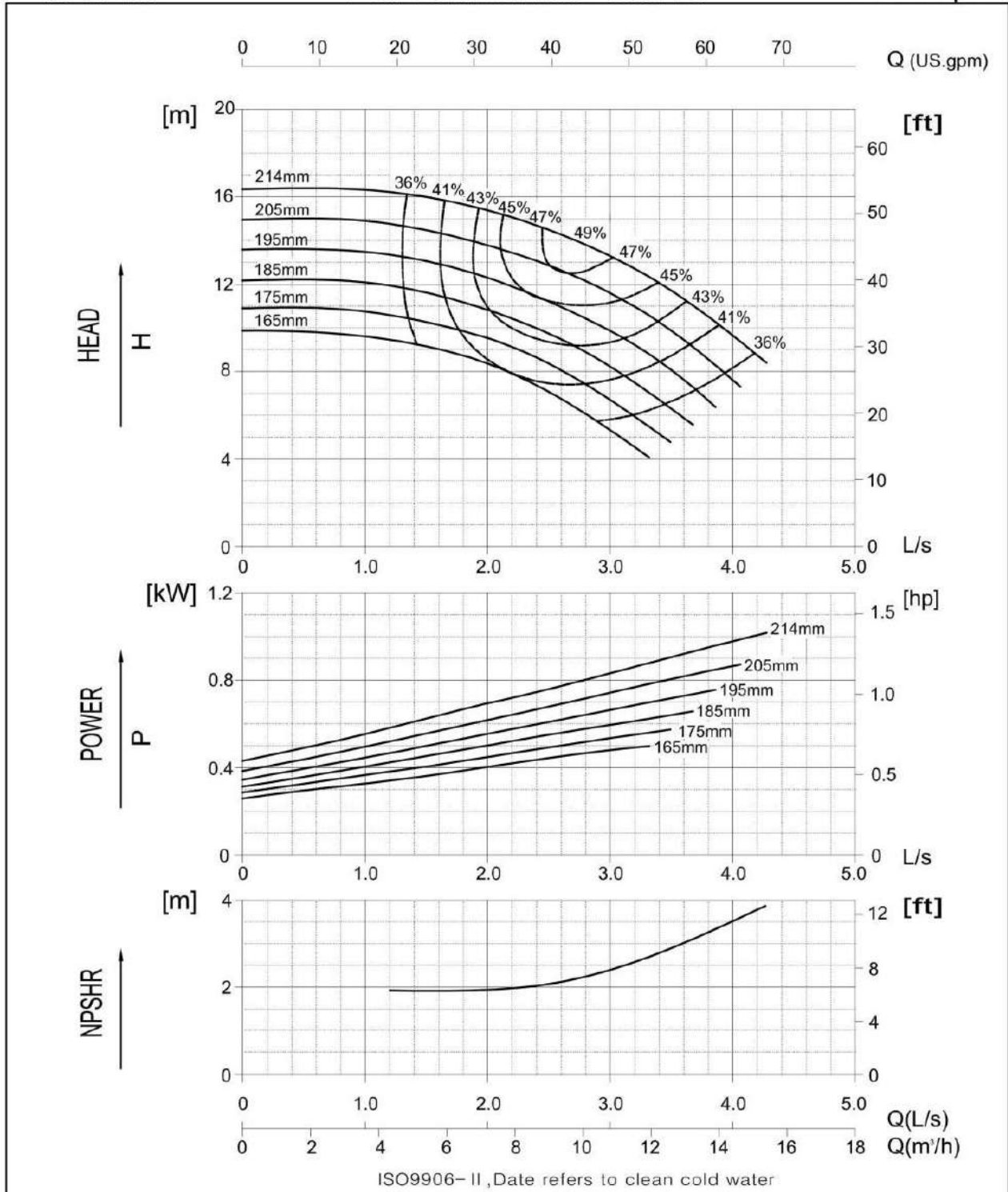

P1701A



BS EN 733/DIN 24255

50-32-260

Performance Curve

1450 rpm

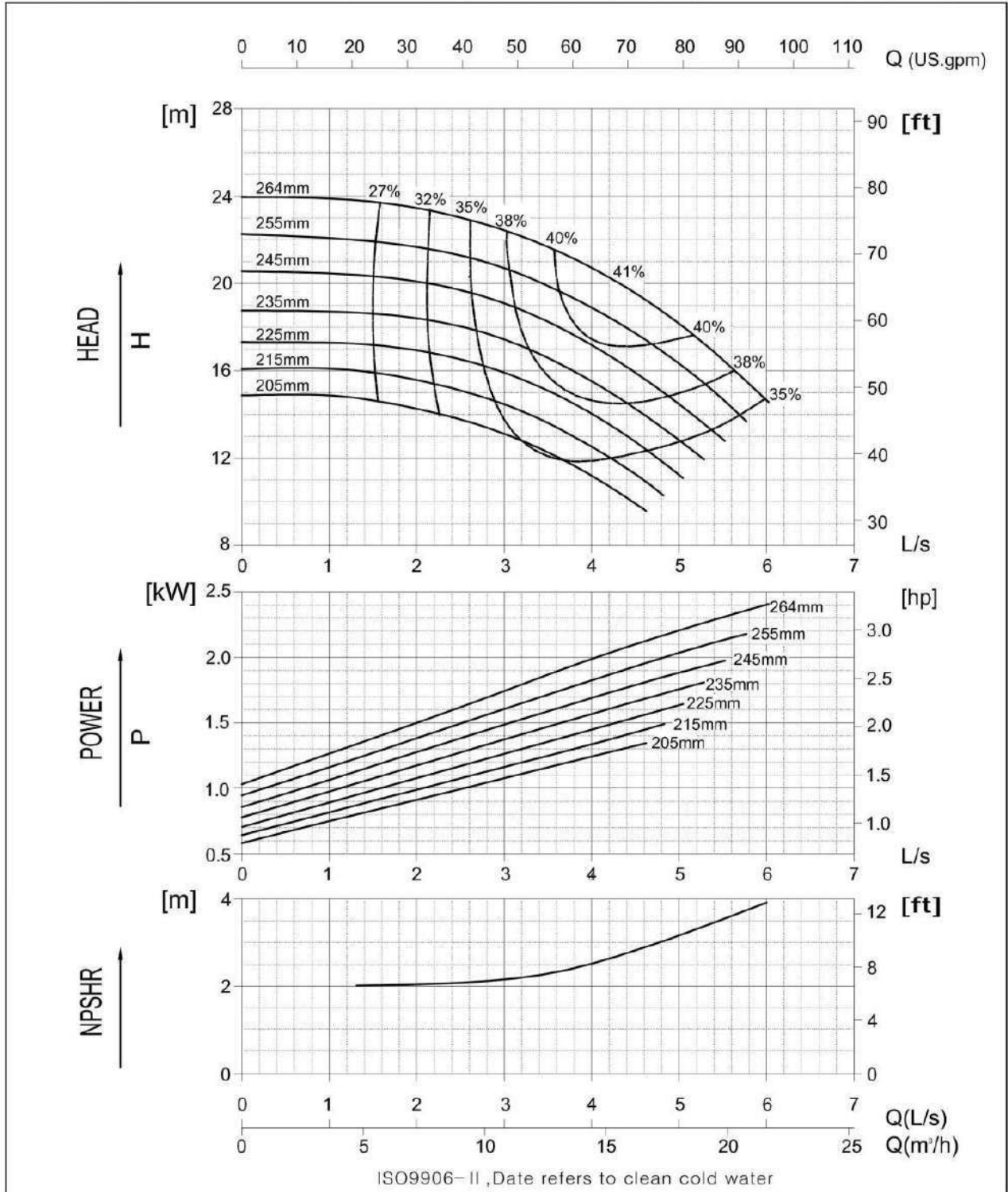

P1701A



BS EN 733/DIN 24255

65-40-130

Performance Curve

1450 rpm

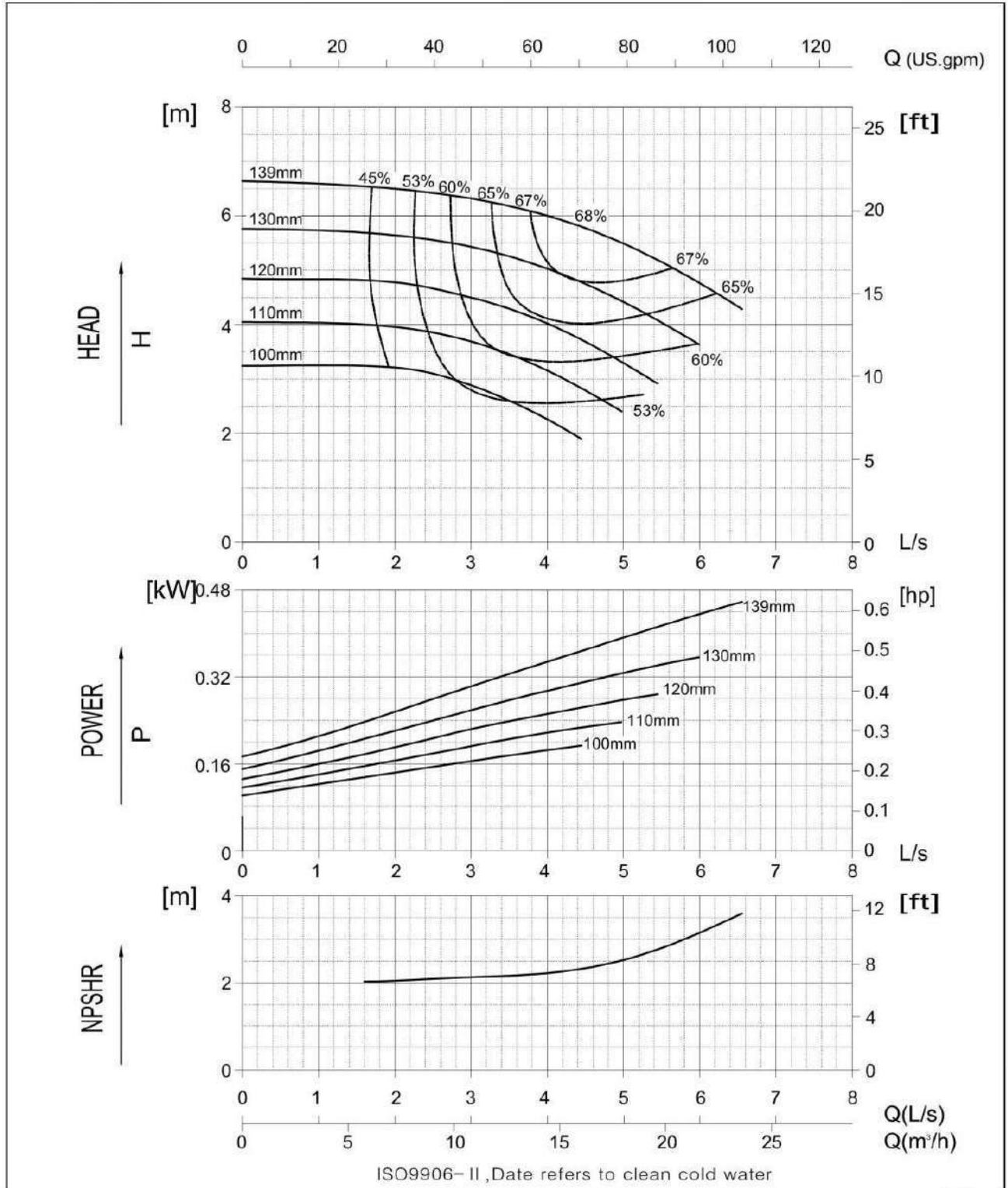

P1701A



BS EN 733/DIN 24255

65-40-160

Performance Curve

1450 rpm

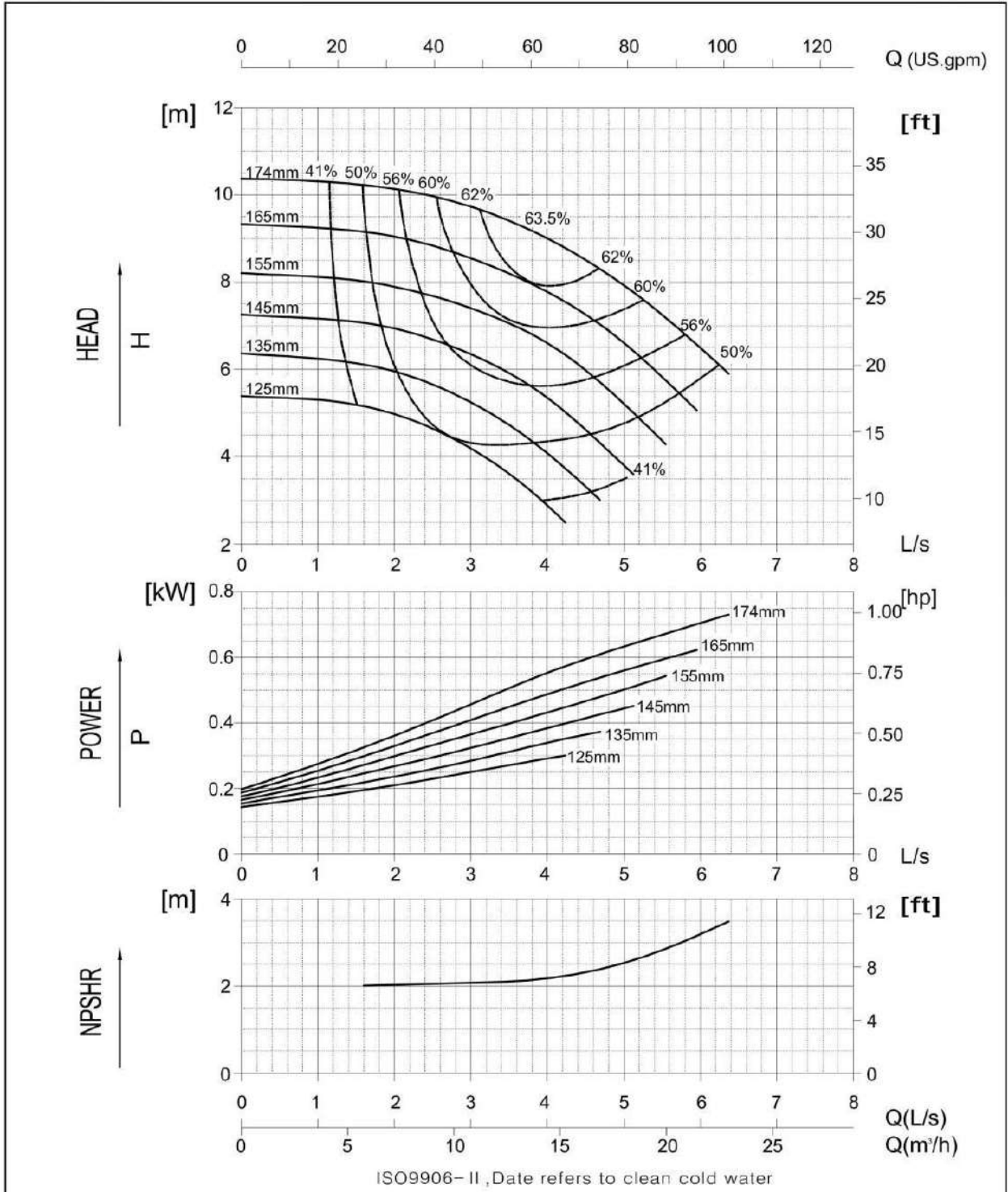

P1701A





BS EN 733/DIN 24255

65-40-200

Performance Curve

1450 rpm

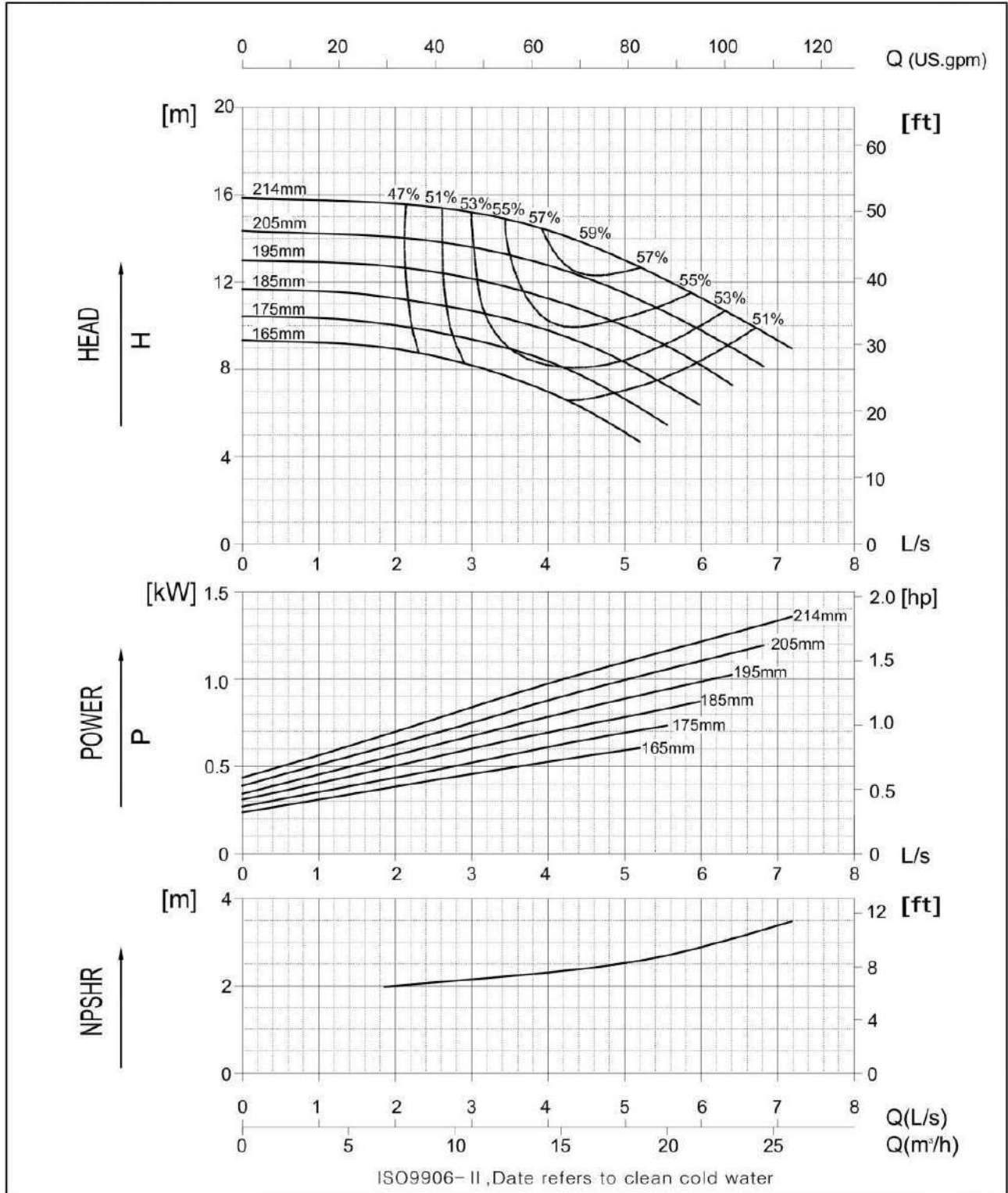

P1701A



BS EN 733/DIN 24255

65-40-260

Performance Curve

1450 rpm

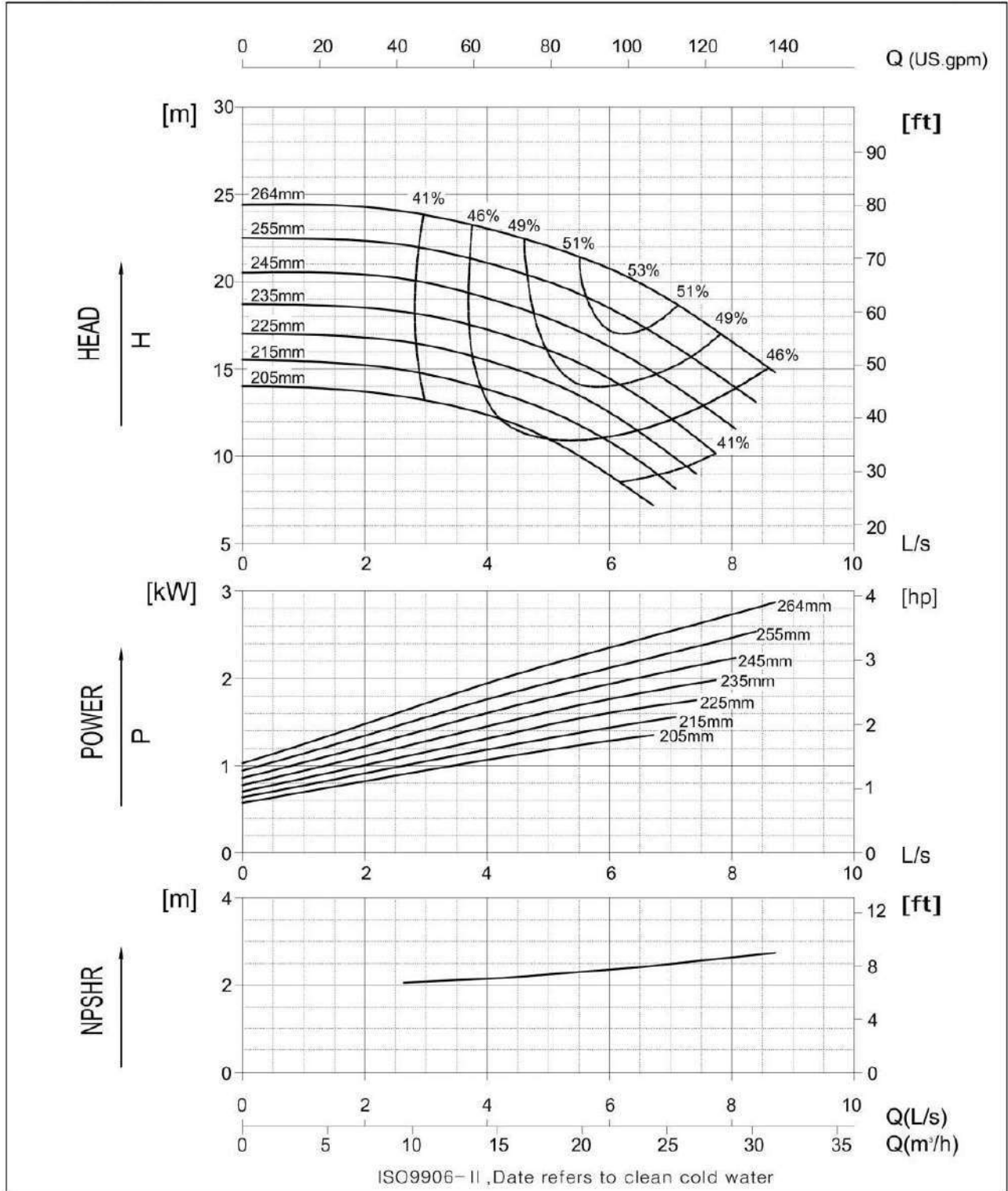

P1701A



BS EN 733/DIN 24255

65-40-320

Performance Curve

1450 rpm

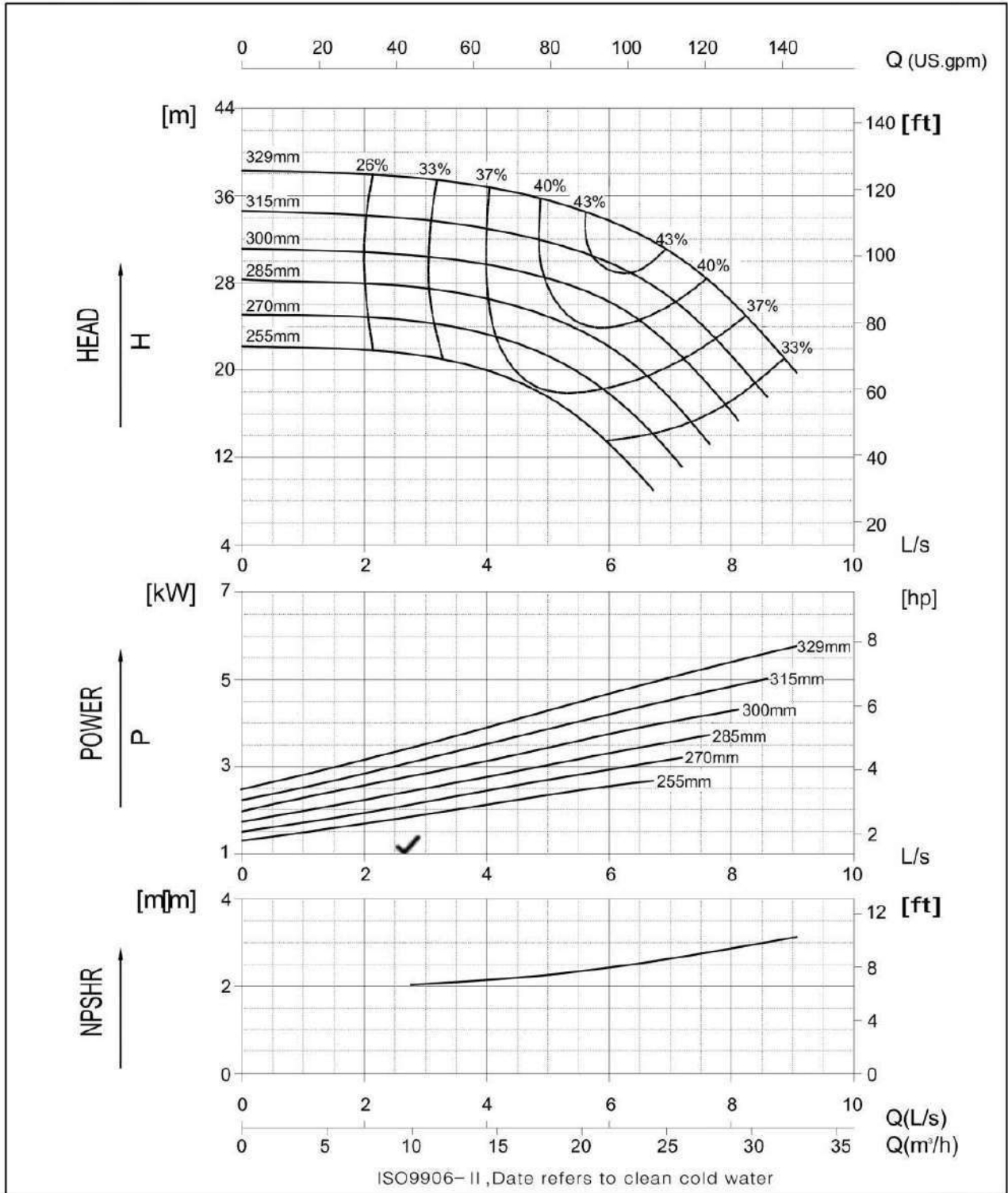

P1701A

BS EN 733/DIN 24255

65-50-130

Performance Curve

1450 rpm

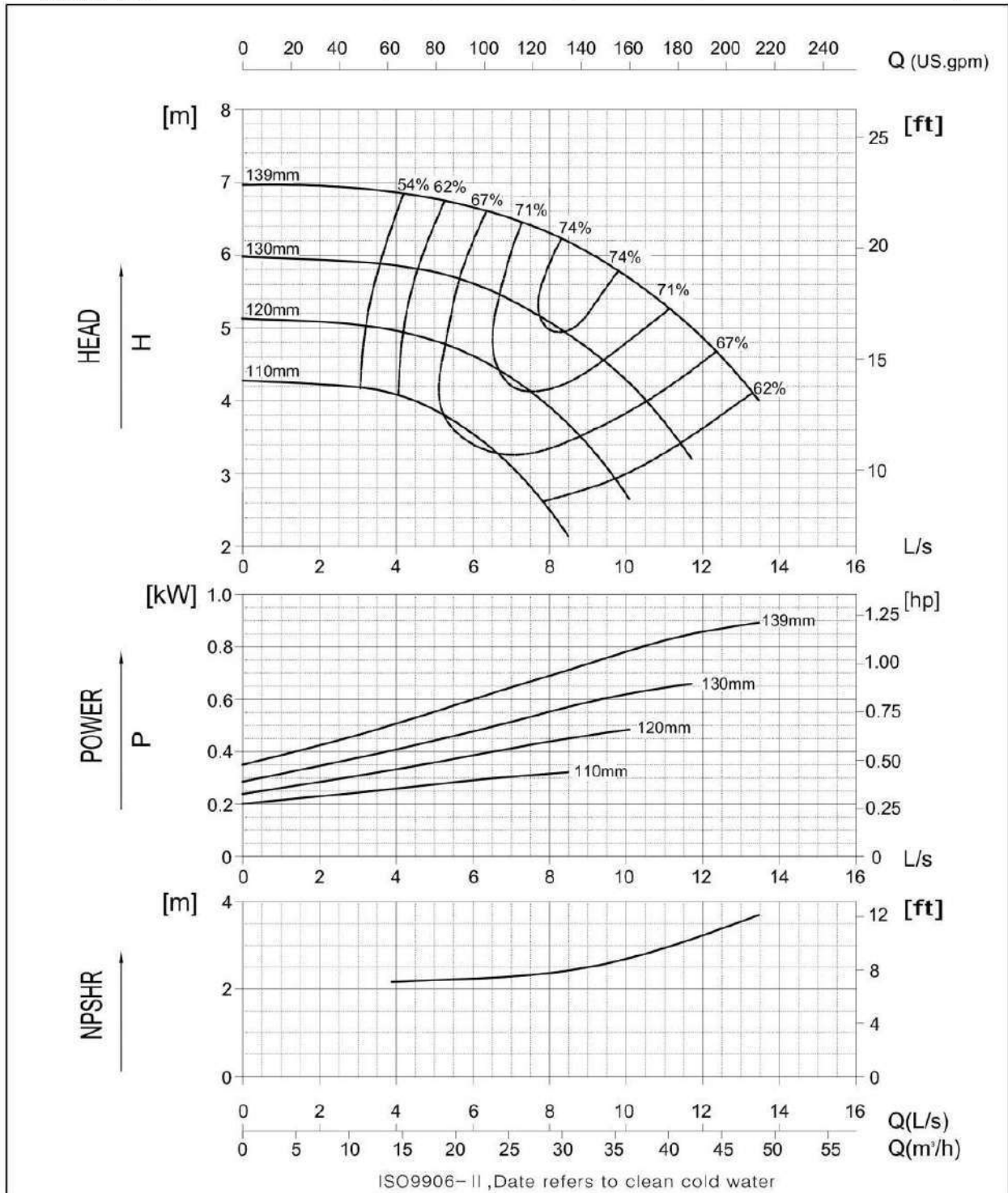

P1701A

BS EN 733/DIN 24255

65-50-160

Performance Curve

1450 rpm

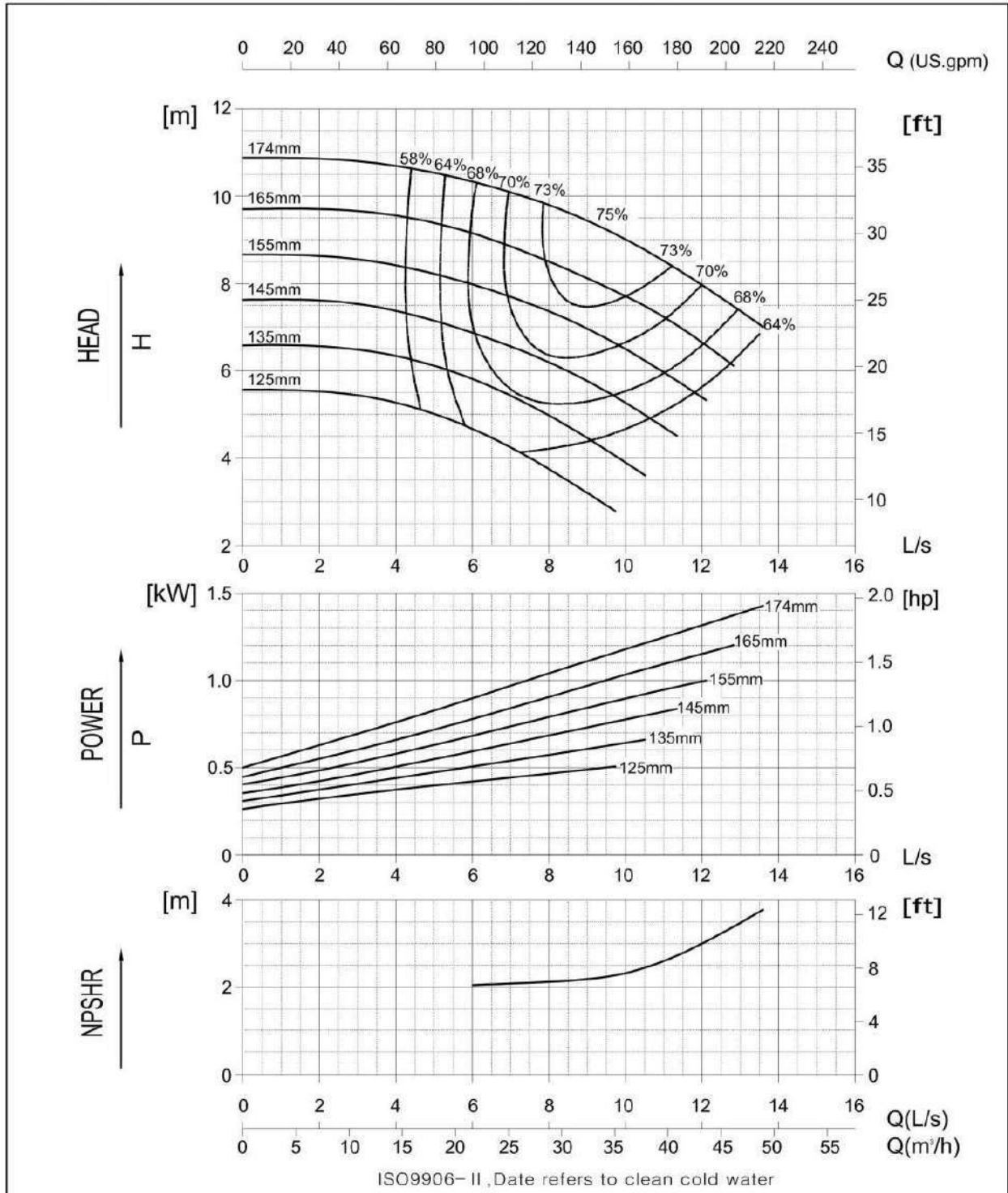

P1701A



BS EN 733/DIN 24255

65-50-200

Performance Curve

1450 rpm

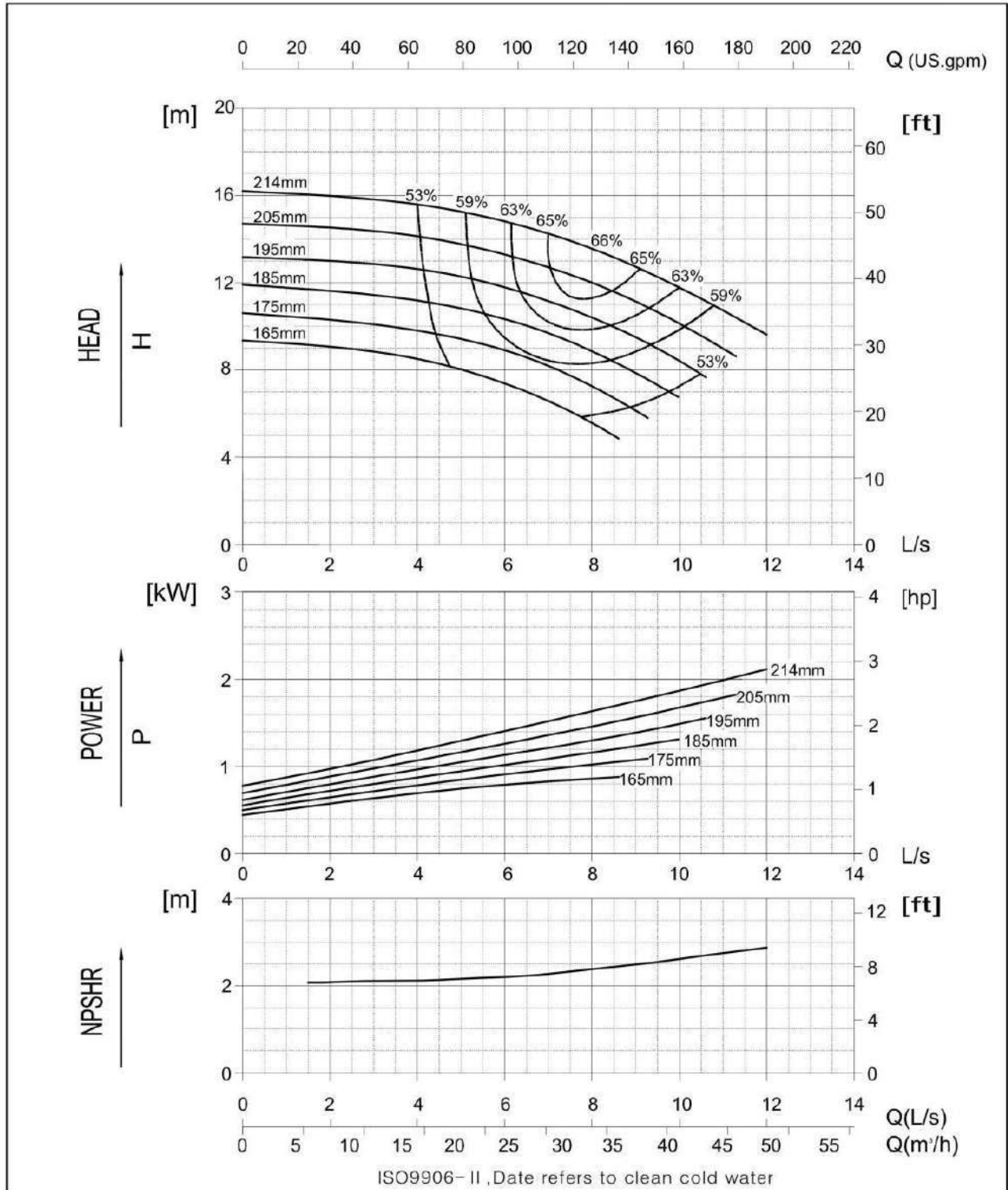

P1701A



BS EN 733/DIN 24255

65-50-260

Performance Curve

1450 rpm

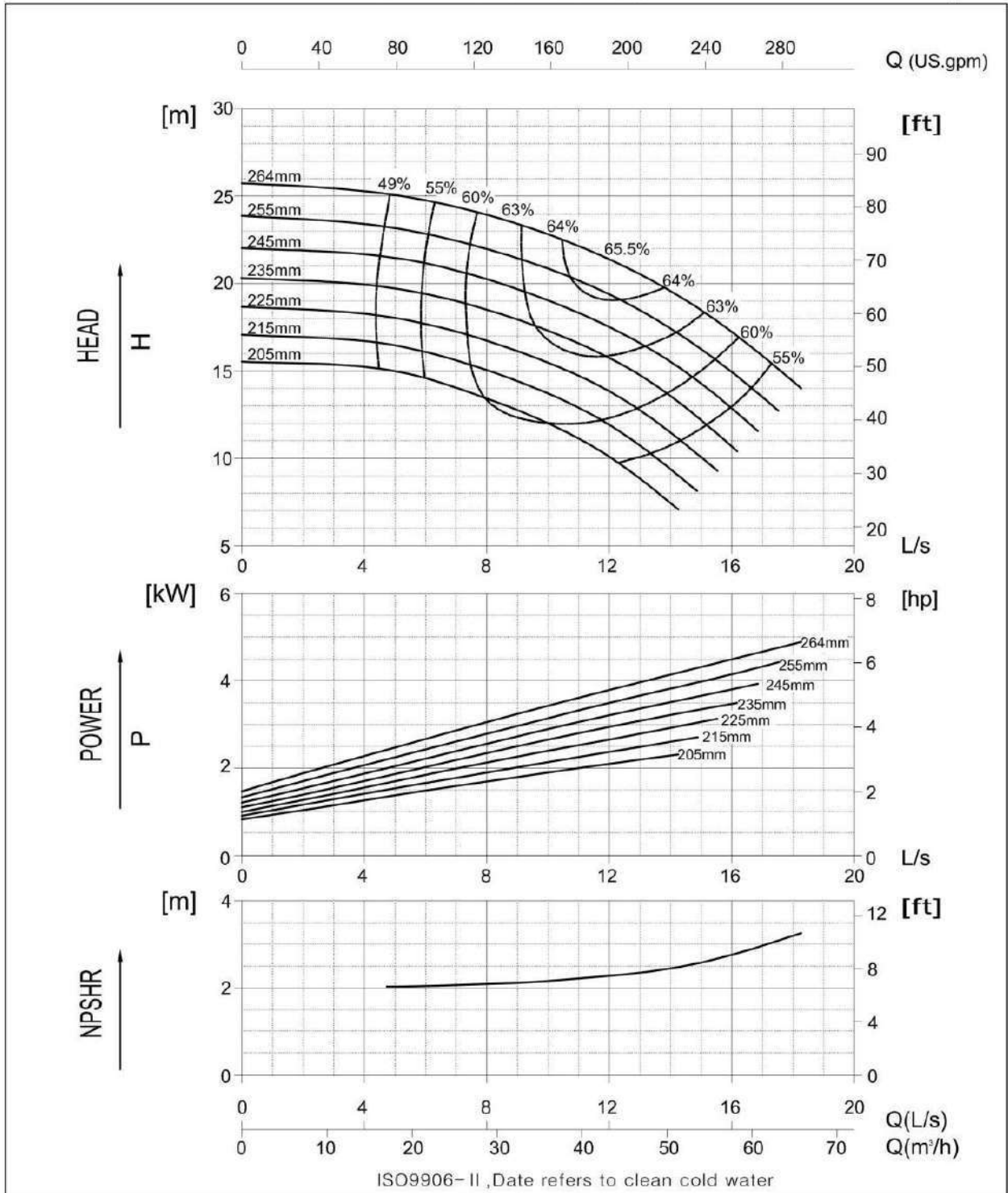

P1701A



BS EN 733/DIN 24255

65-50-320

Performance Curve

1450 rpm

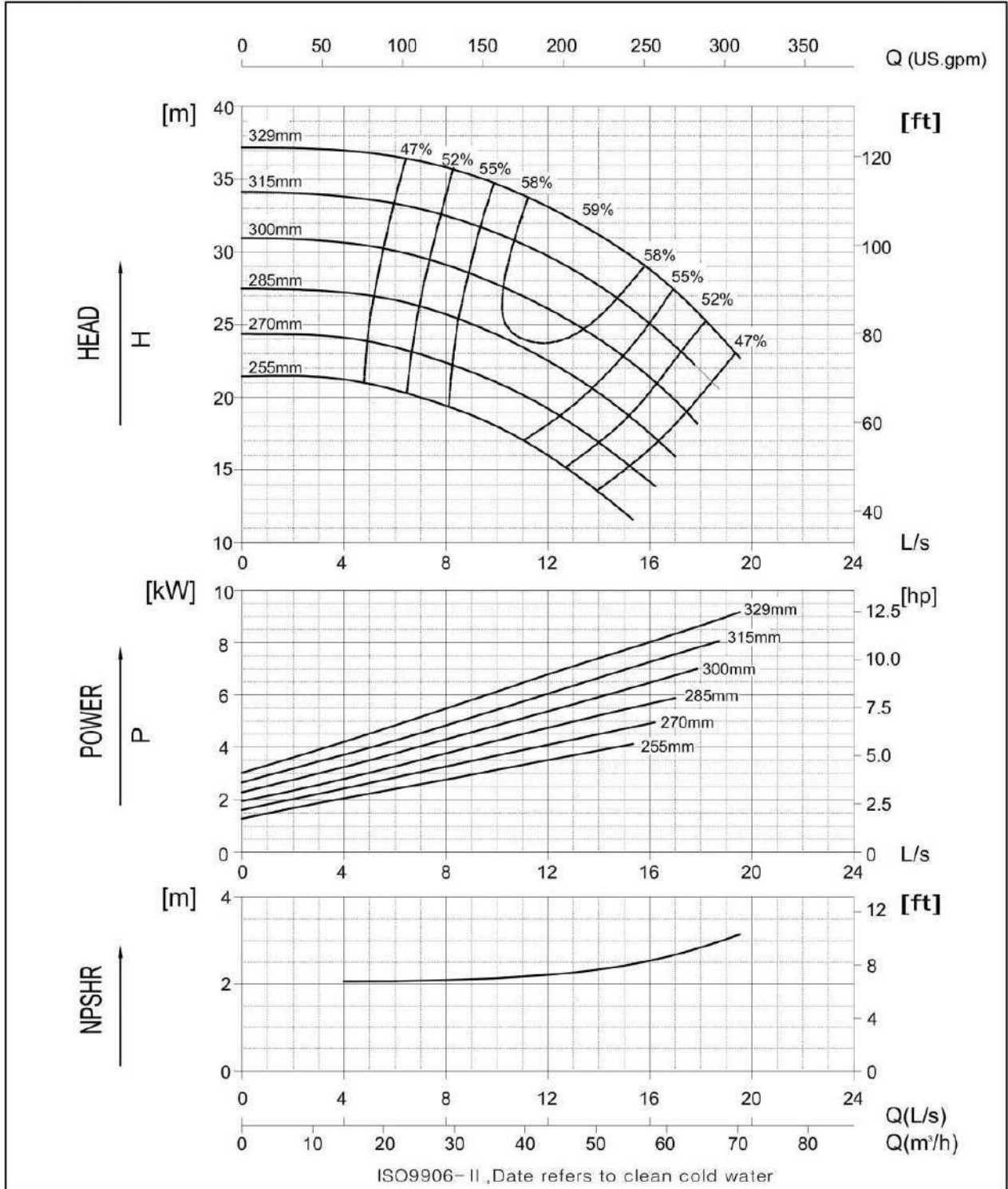

P1701A





BS EN 733/DIN 24255

80-65-130

Performance Curve

1450 rpm

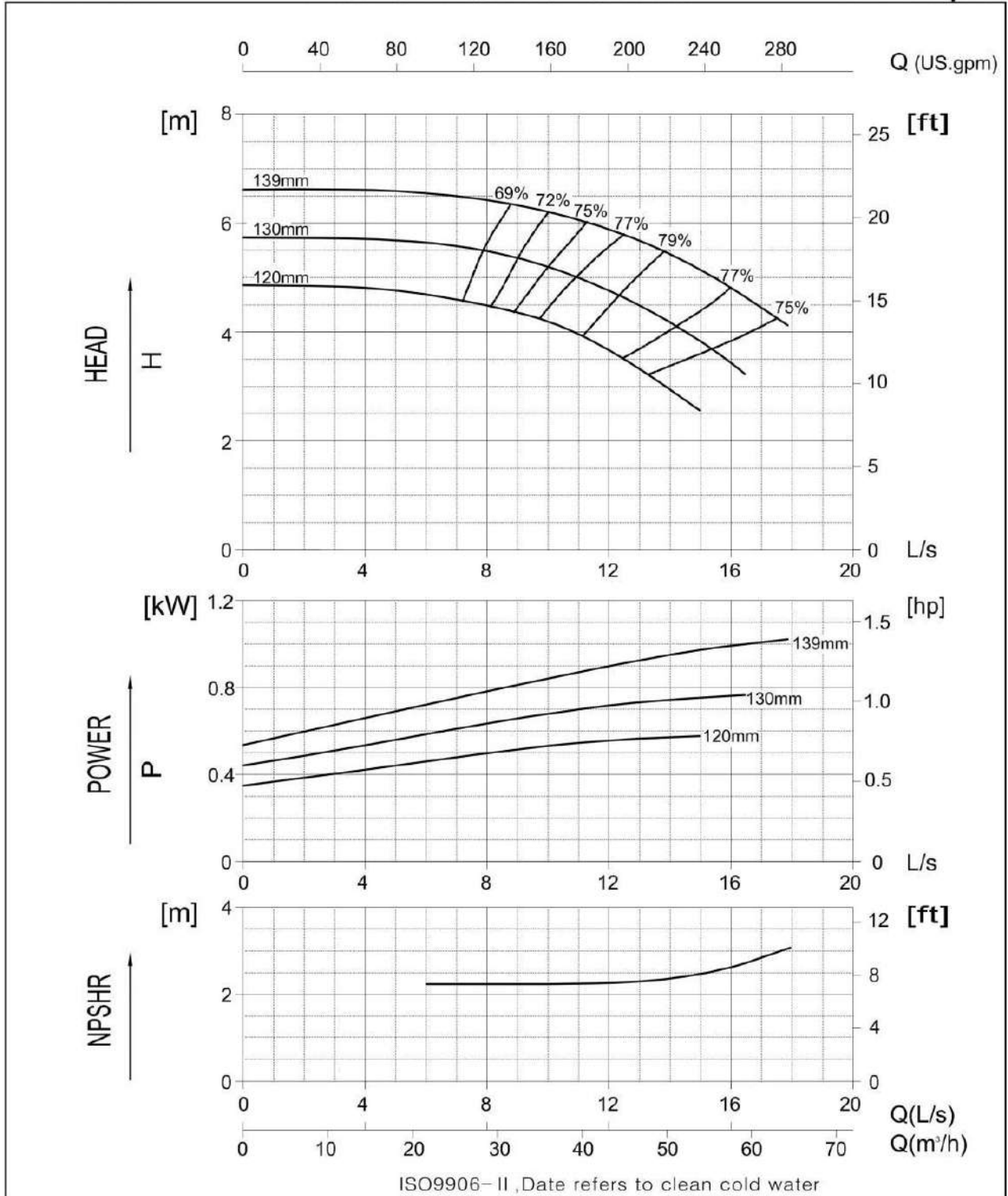

P1701A

BS EN 733/DIN 24255

80-65-160

Performance Curve

1450 rpm

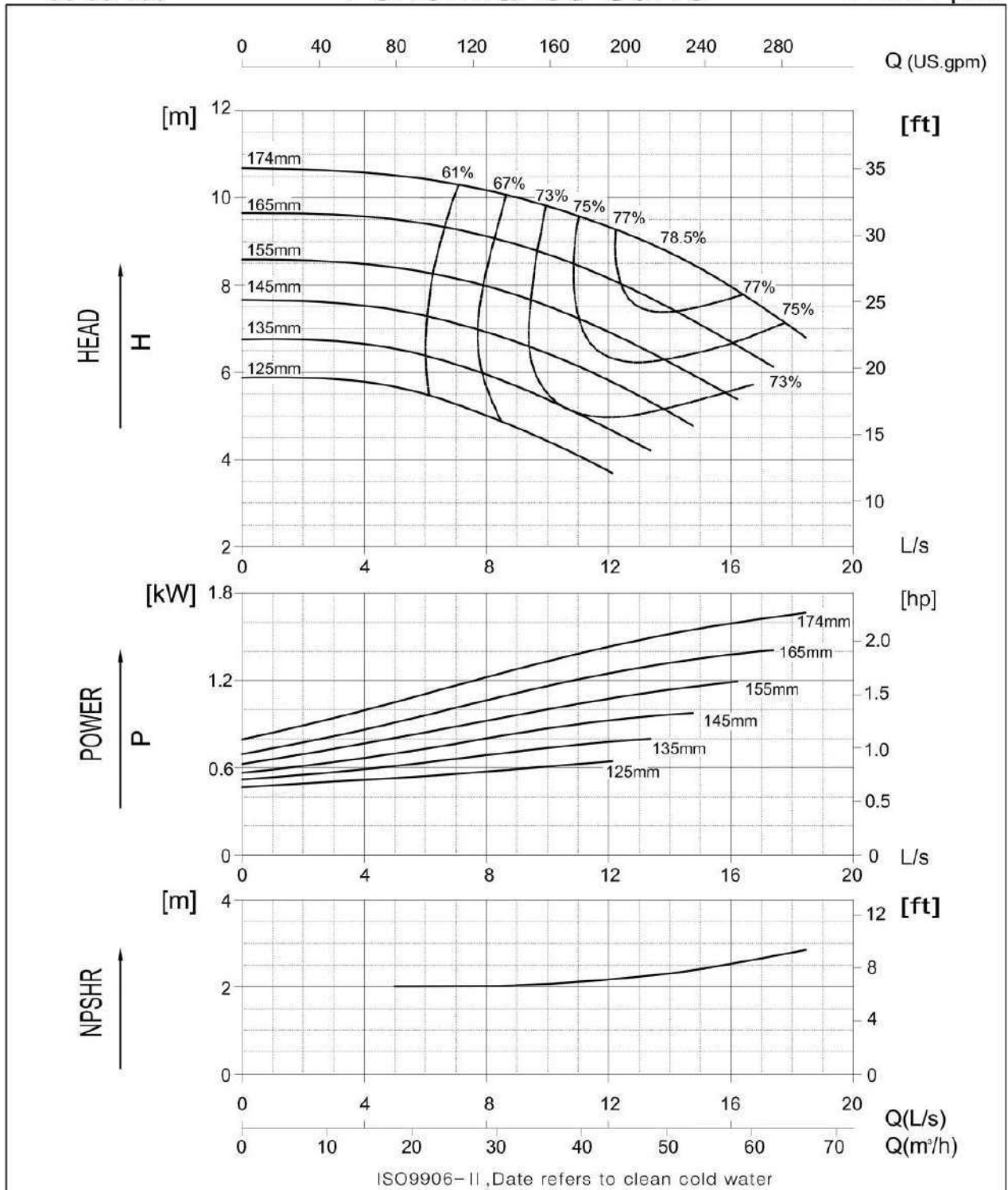

P1701A

BS EN 733/DIN 24255

80-65-200

Performance Curve

1450 rpm

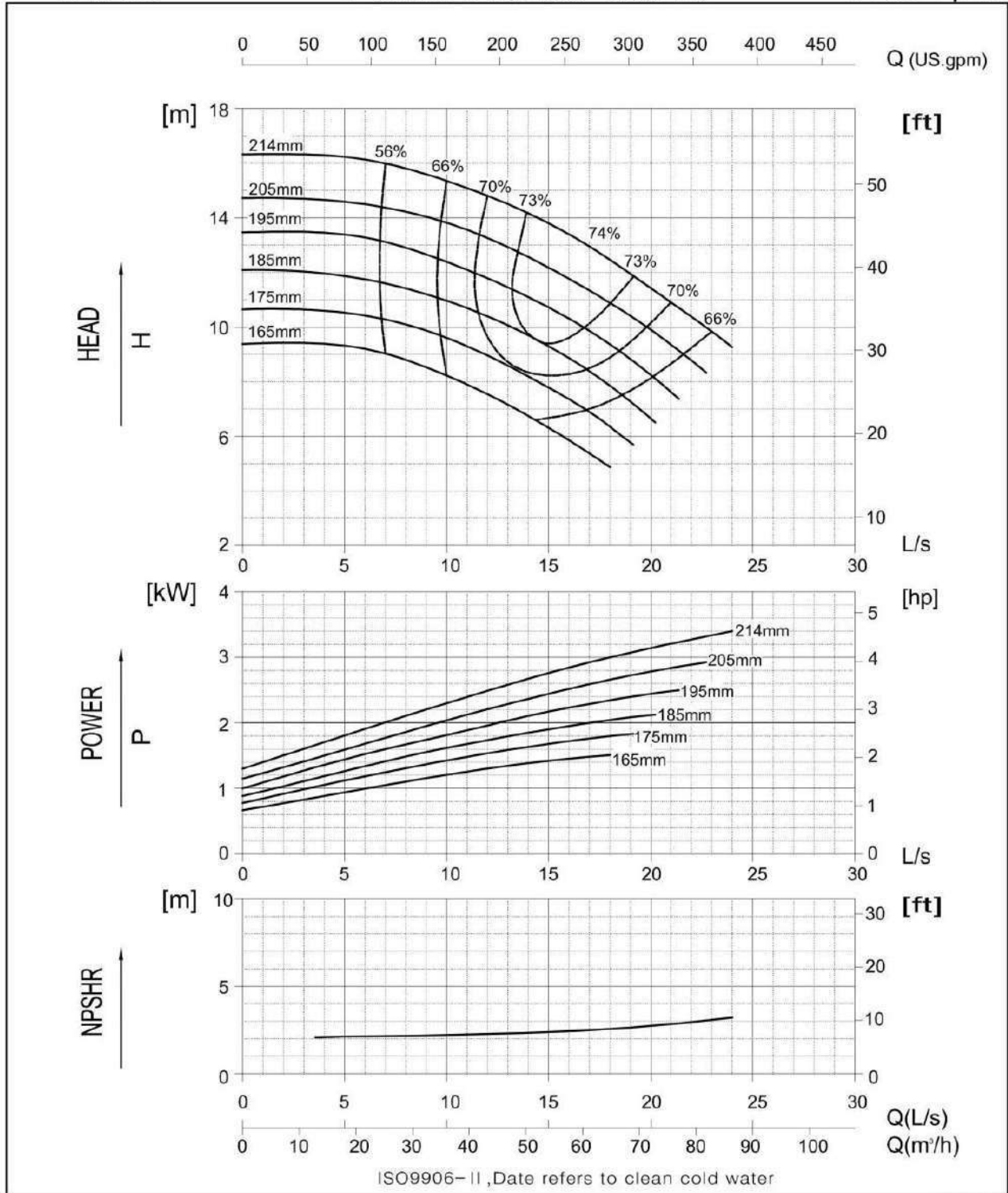

P1701A

BS EN 733/DIN 24255

80-65-260

Performance Curve

1450 rpm

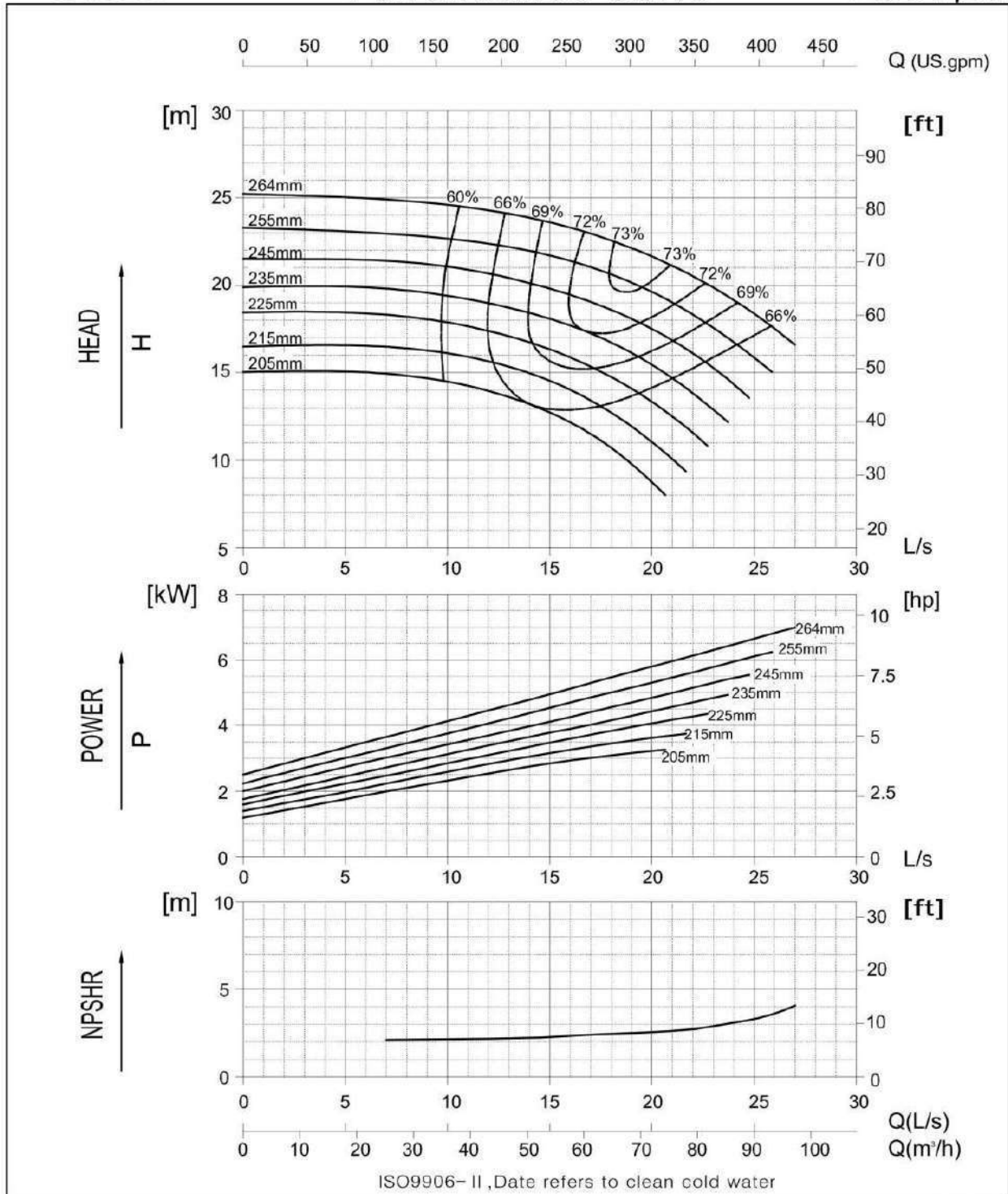

P1701A



BS EN 733/DIN 24255

80-65-320

Performance Curve

1450 rpm

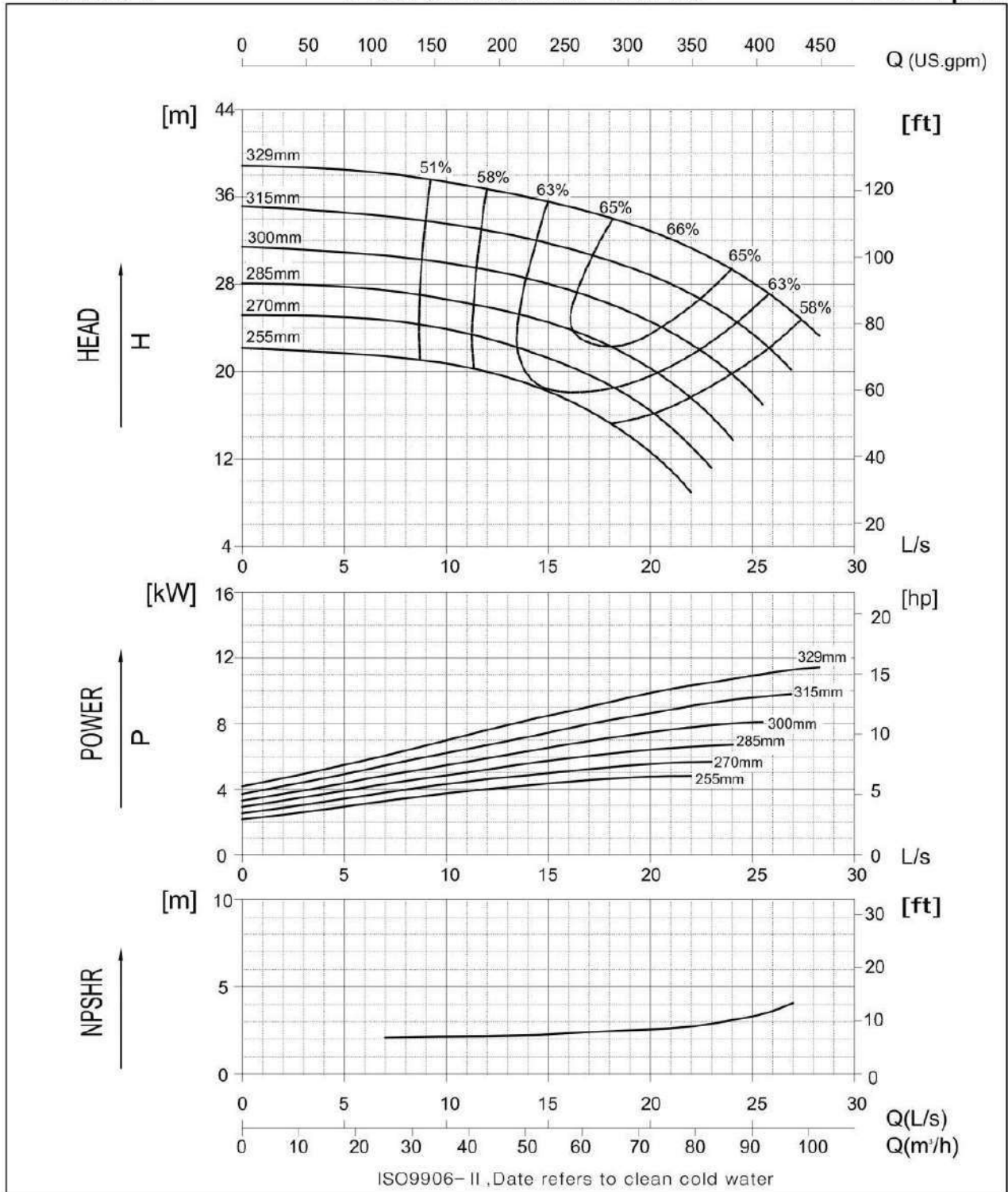

P1701A



BS EN 733/DIN 24255

100-80-160

Performance Curve

1450 rpm

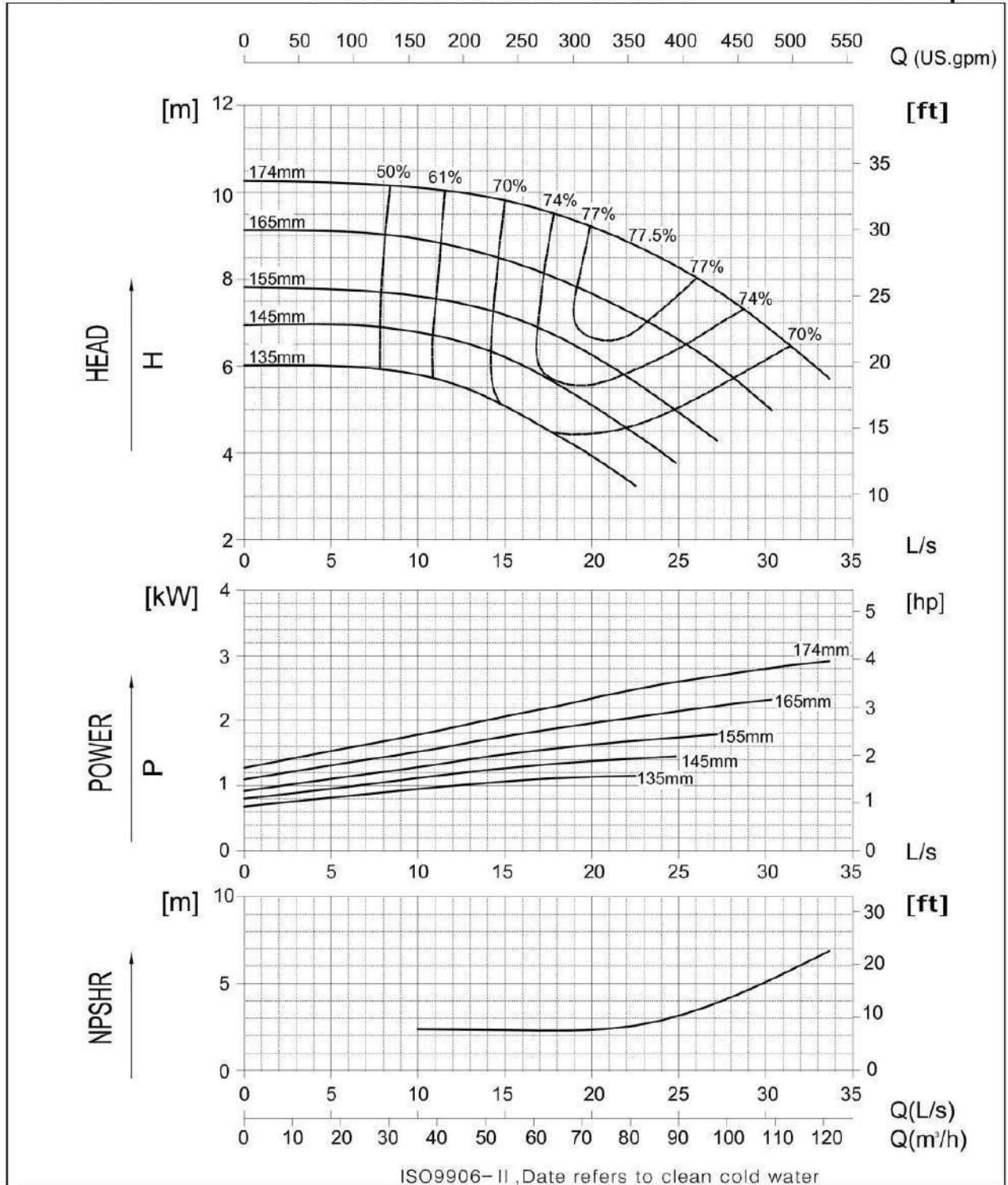

P1701A



BS EN 733/DIN 24255

100-80-200

Performance Curve

1450 rpm

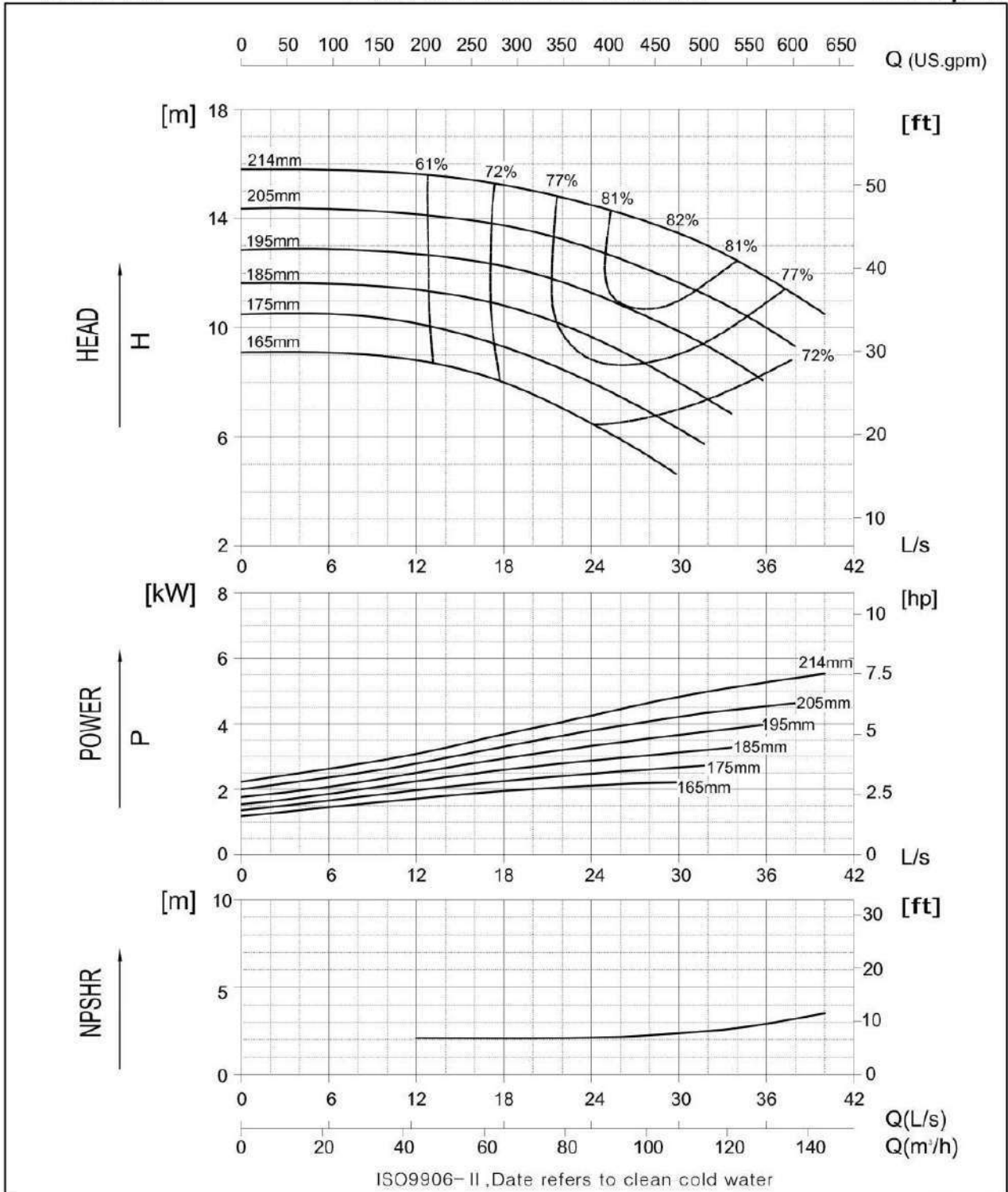

P1701A



BS EN 733/DIN 24255

100-80-260

Performance Curve

1450 rpm

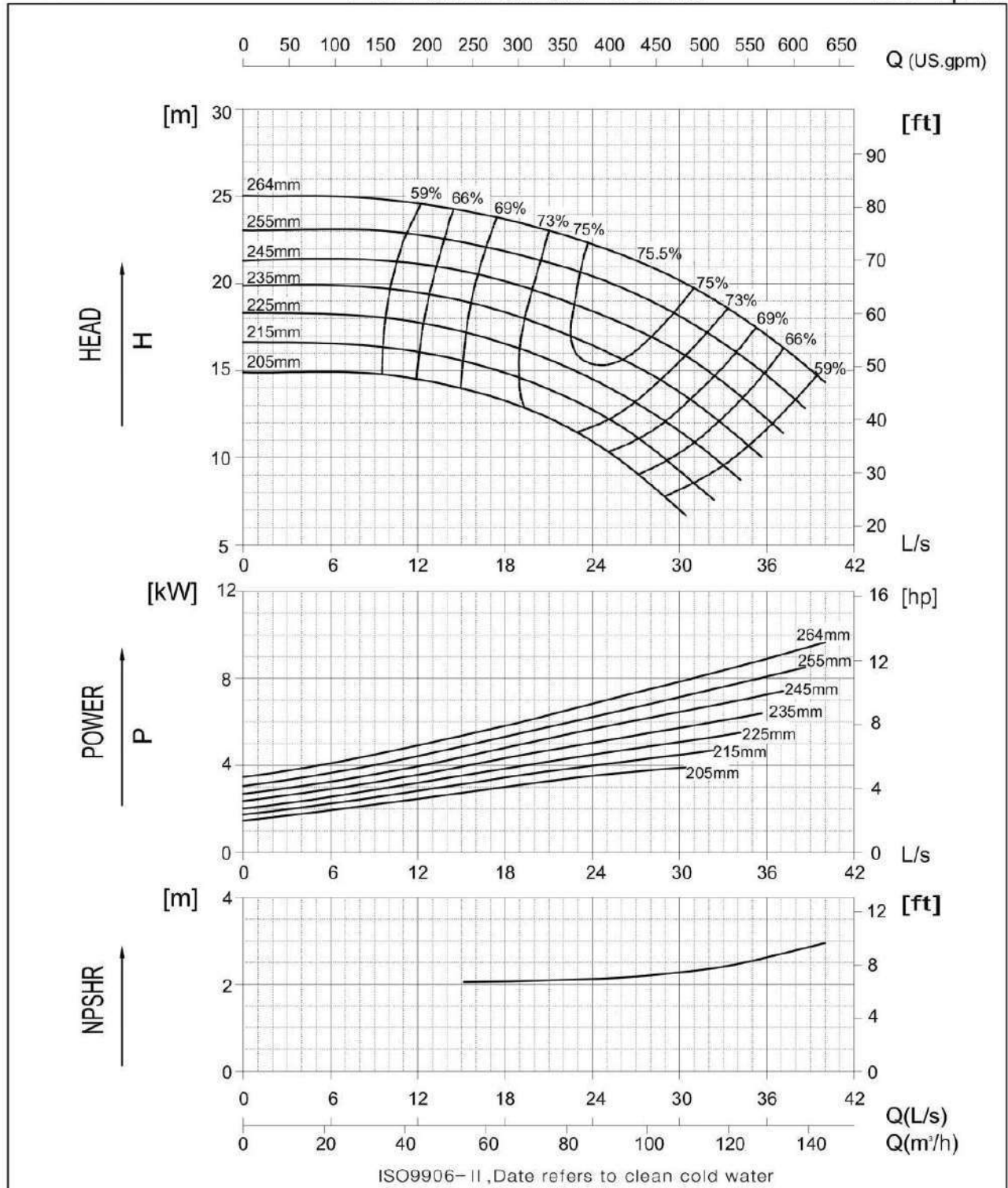

P1701A





BS EN 733/DIN 24255

100-80-320

Performance Curve

1450 rpm

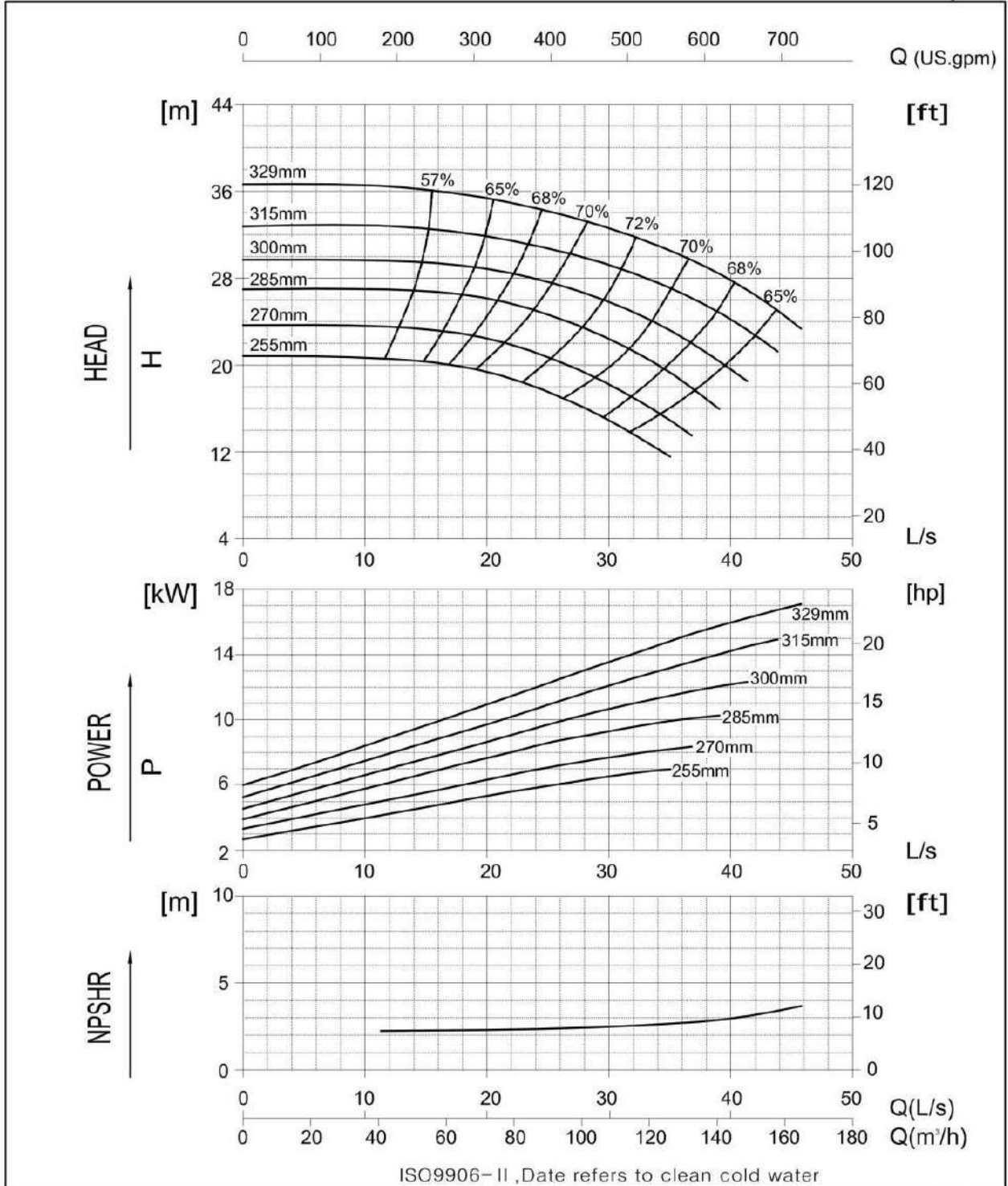

ISO9906-II, Date refers to clean cold water

P1701A



BS EN 733/DIN 24255

100-80-400

### Performance Curve

1450 rpm

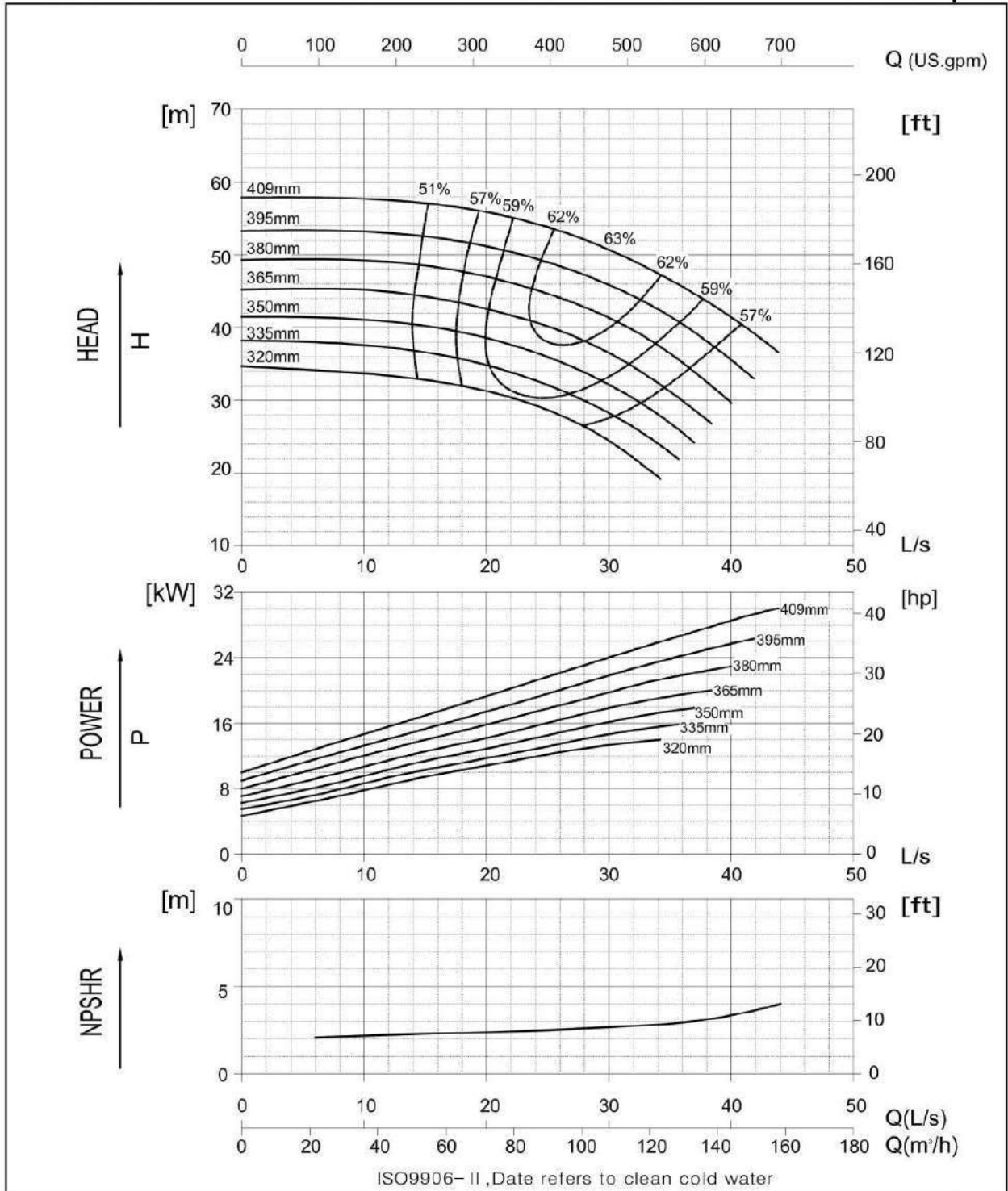

P1701A

BS EN 733/DIN 24255

125-100-160

Performance Curve

1450 rpm

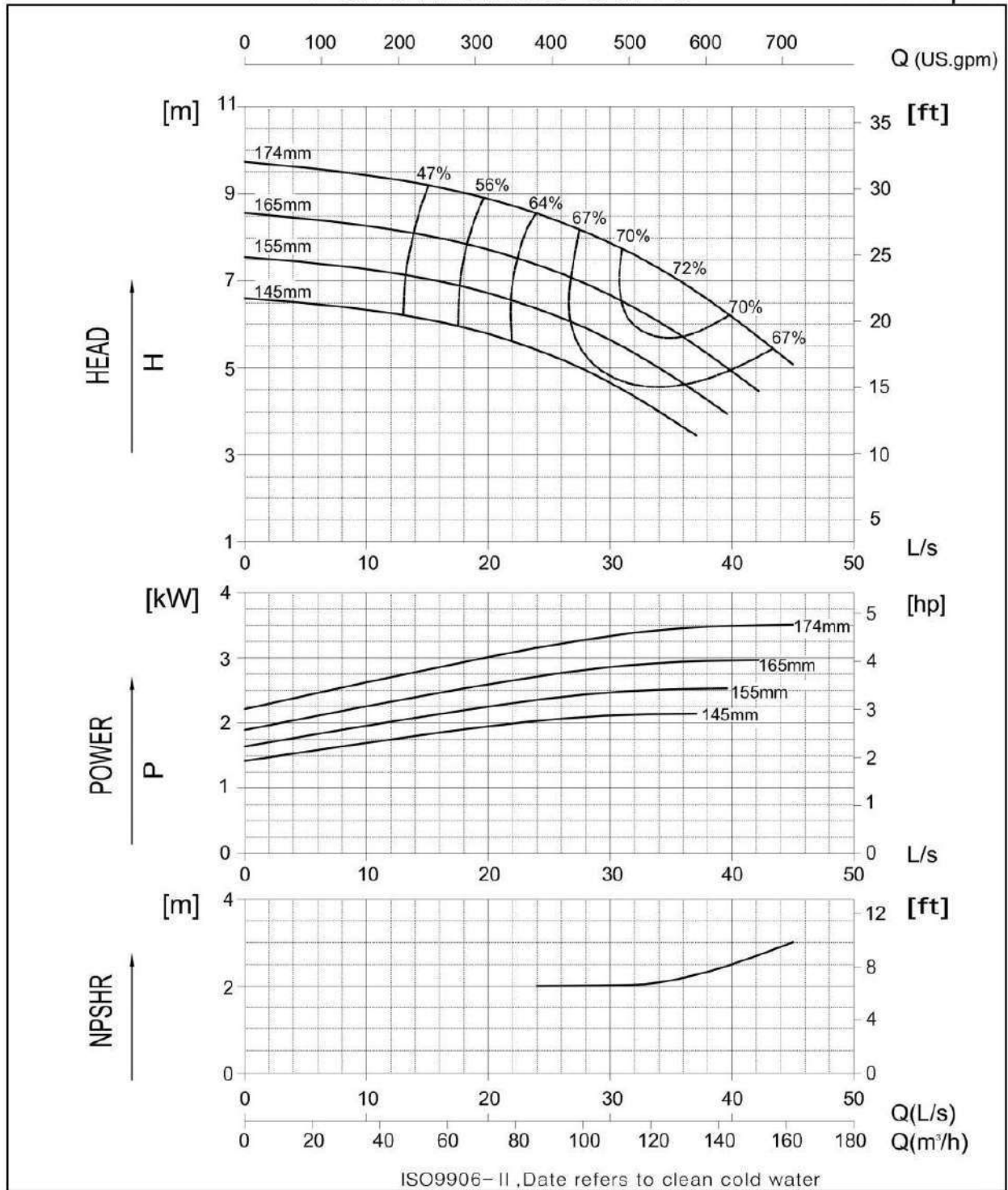

BS EN 733/DIN 24255

125-100-200

Performance Curve

1450 rpm

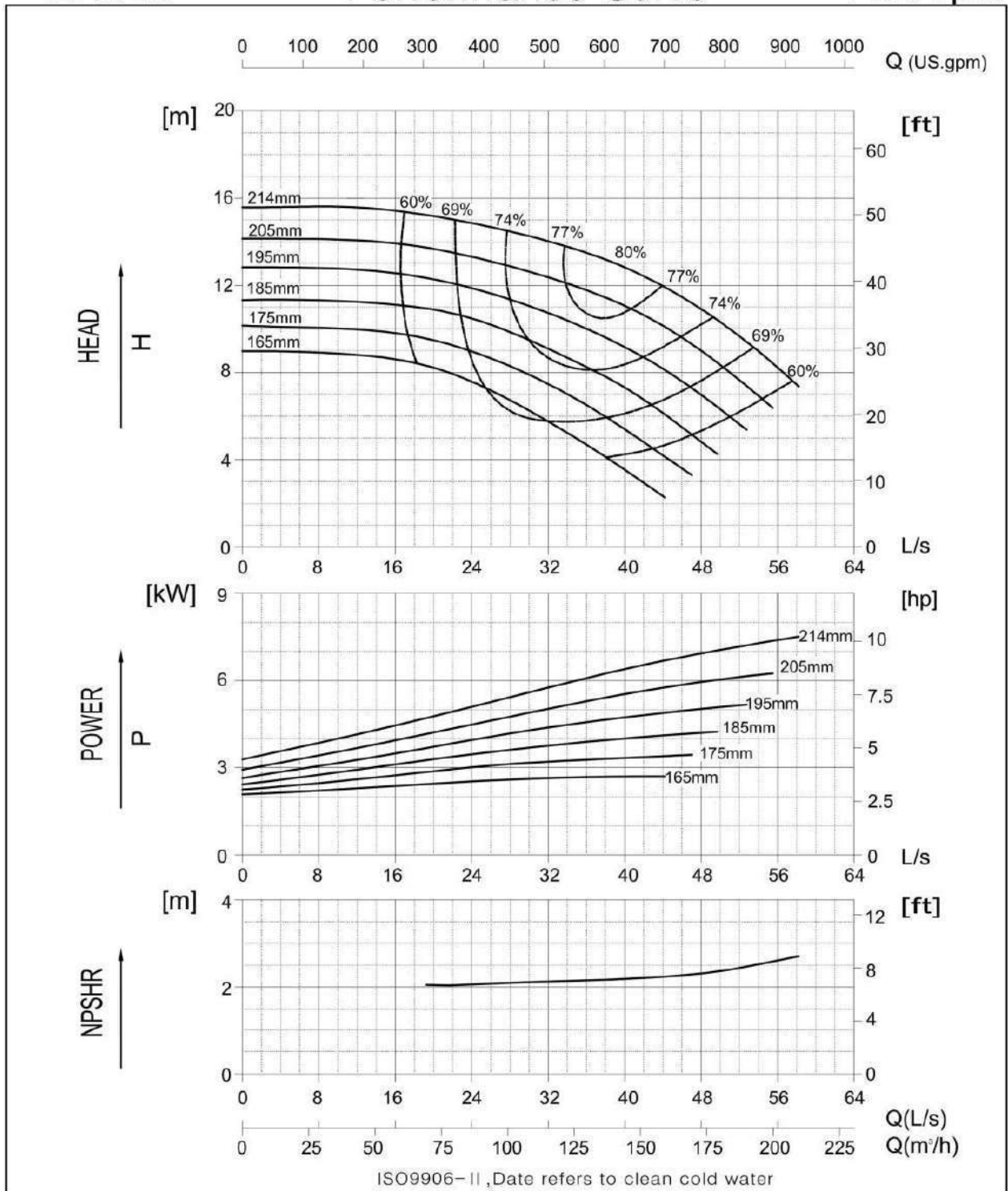

P1701A



BS EN 733/DIN 24255

125-100-260

Performance Curve

1450 rpm

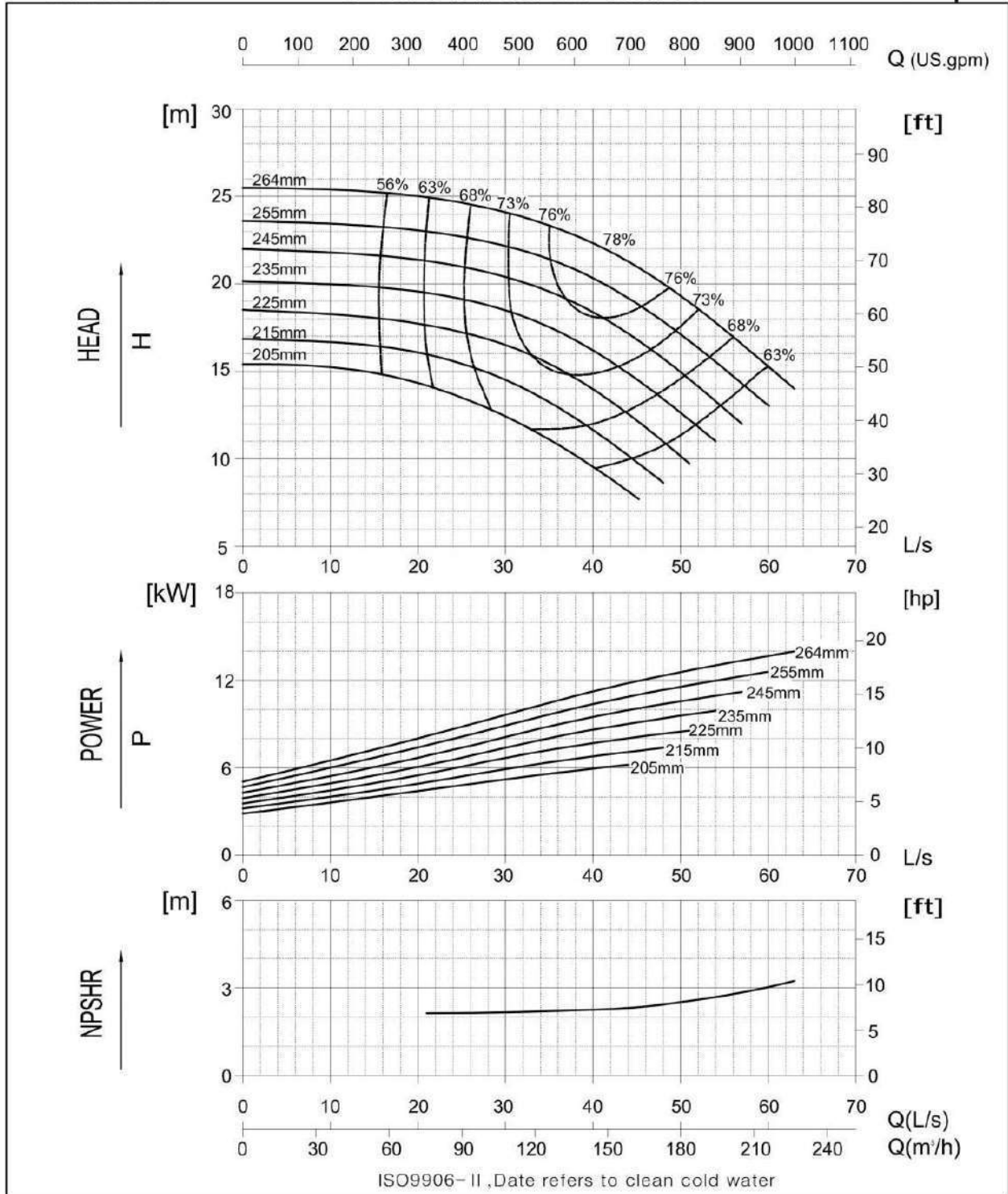

P1701A



BS EN 733/DIN 24255

125-100-320

### Performance Curve

1450 rpm

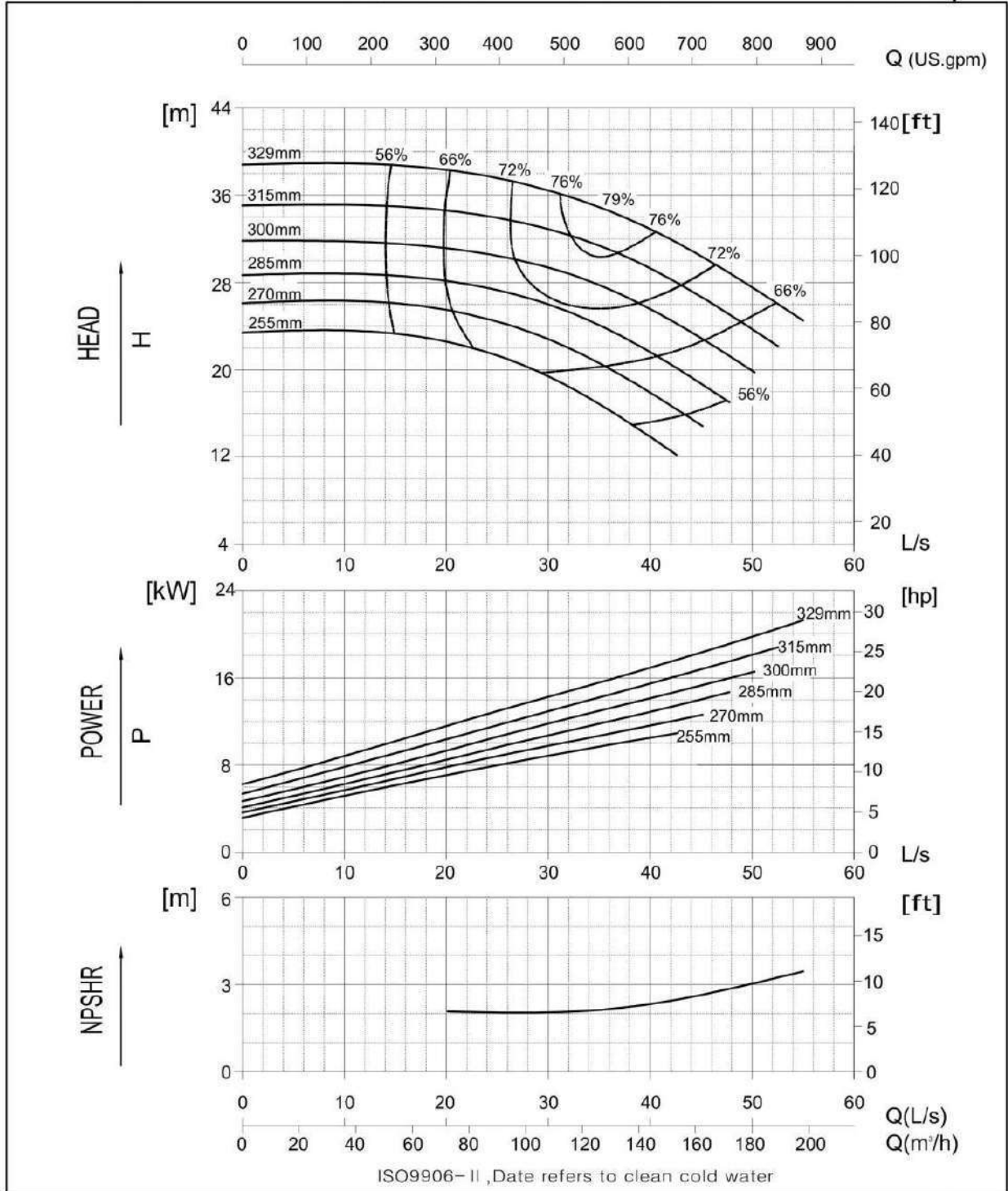

P1701A



BS EN 733/DIN 24255

125-100-400

Performance Curve

1450 rpm

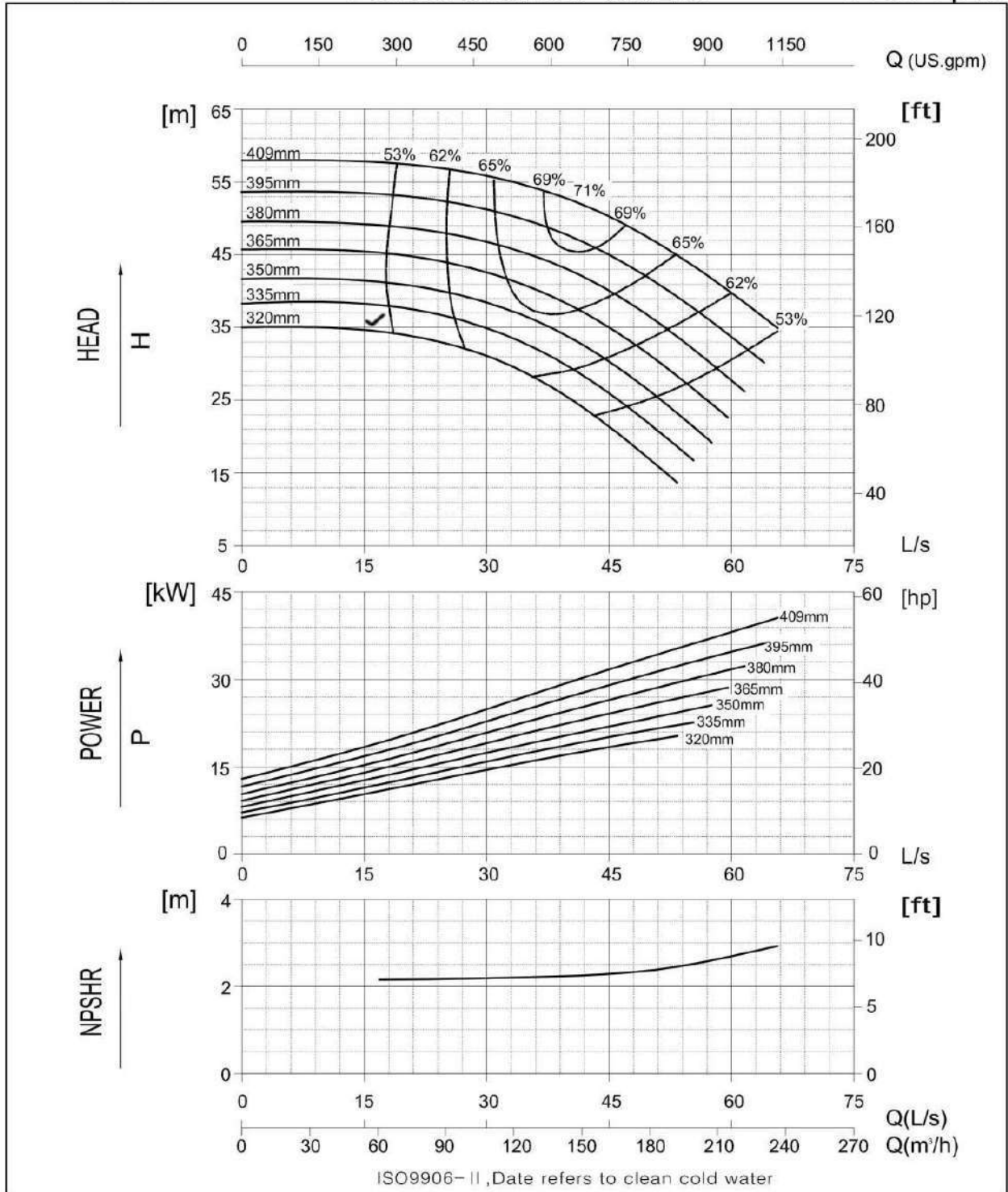

P1701A

BS EN 733/DIN 24255

150-125-200

Performance Curve

1450 rpm

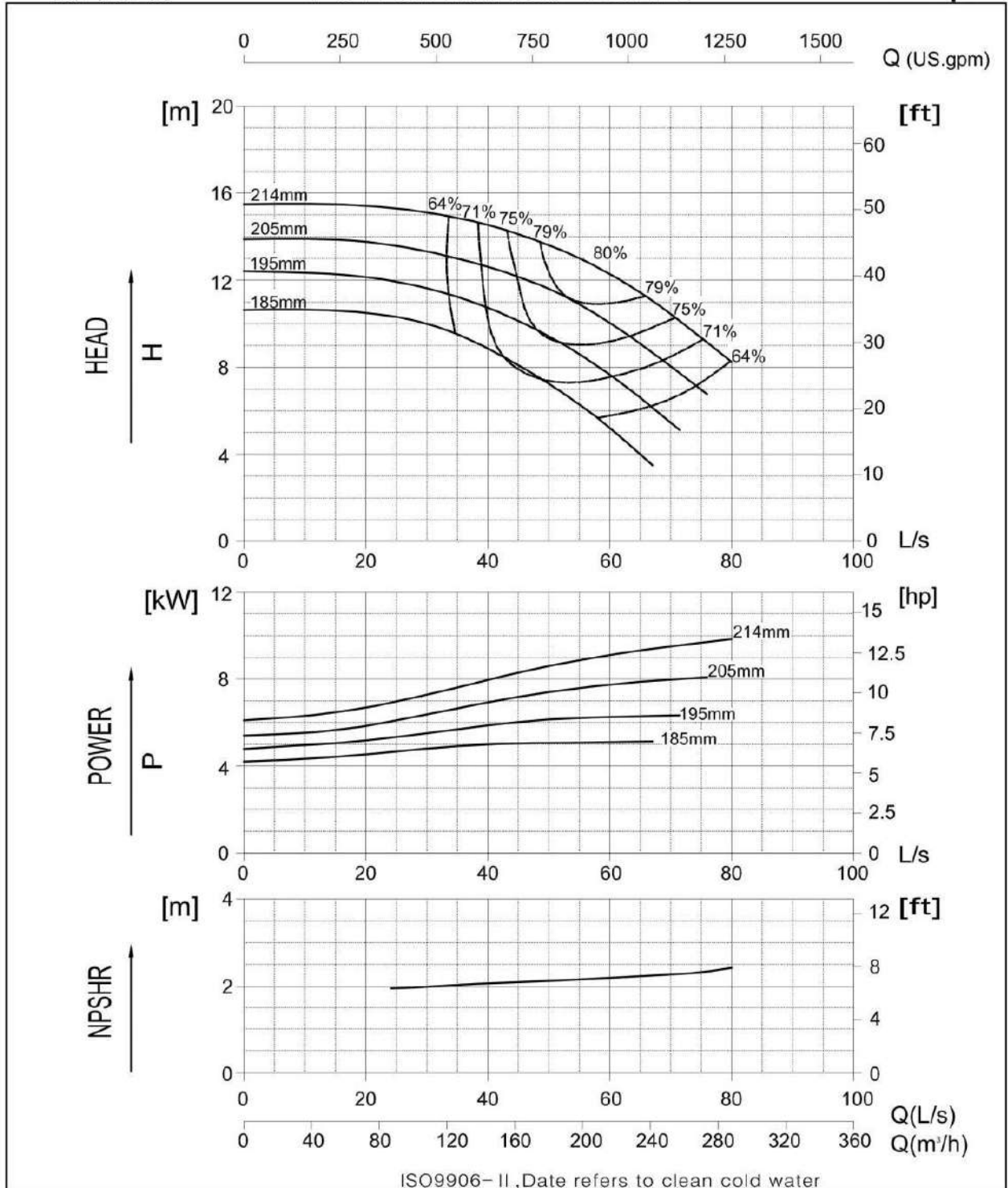

P1701A





BS EN 733/DIN 24255

150-125-260

Performance Curve

1450 rpm

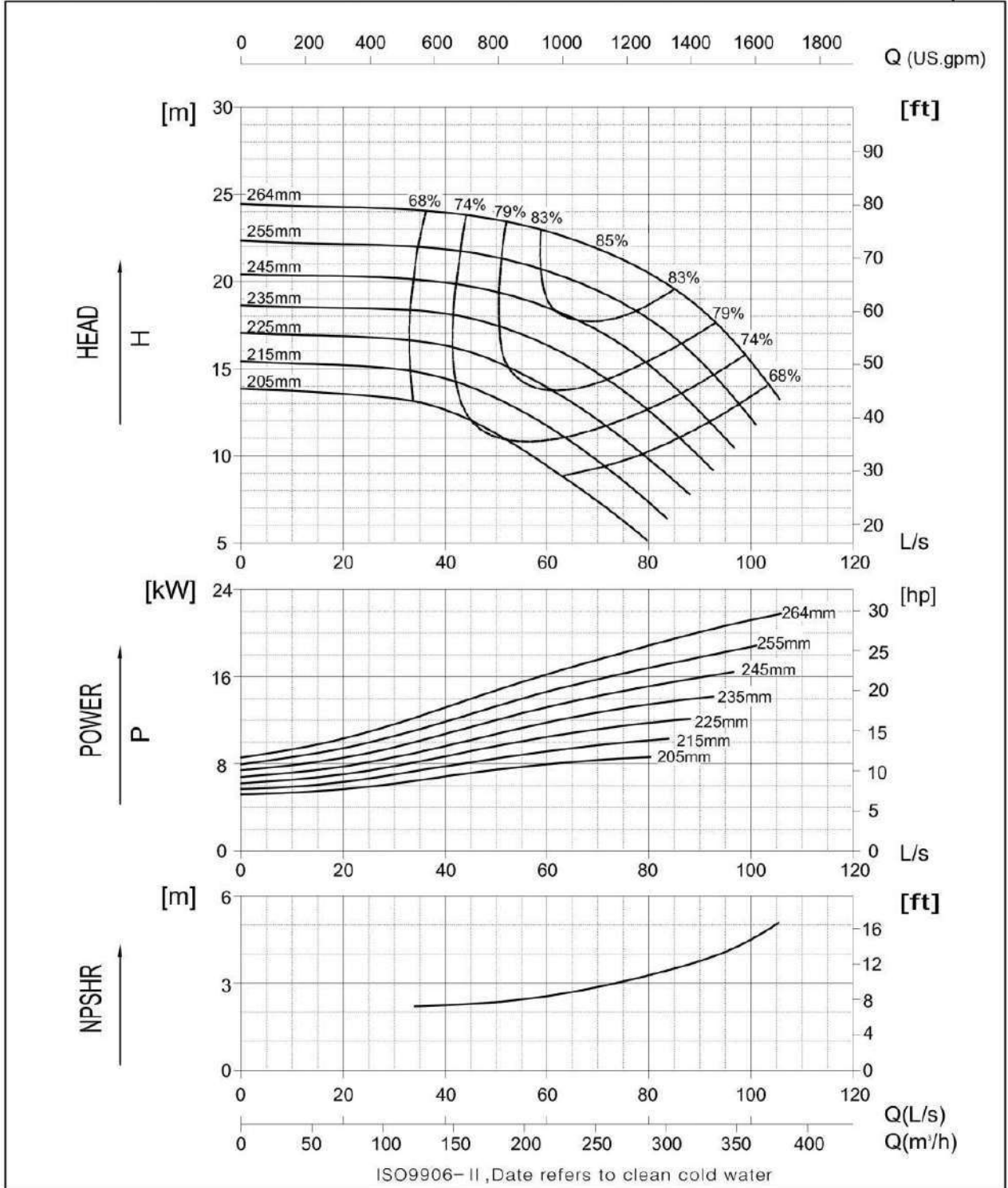

ISO9906-II, Date refers to clean cold water

P1701A



BS EN 733/DIN 24255

150-125-320

Performance Curve

1450 rpm

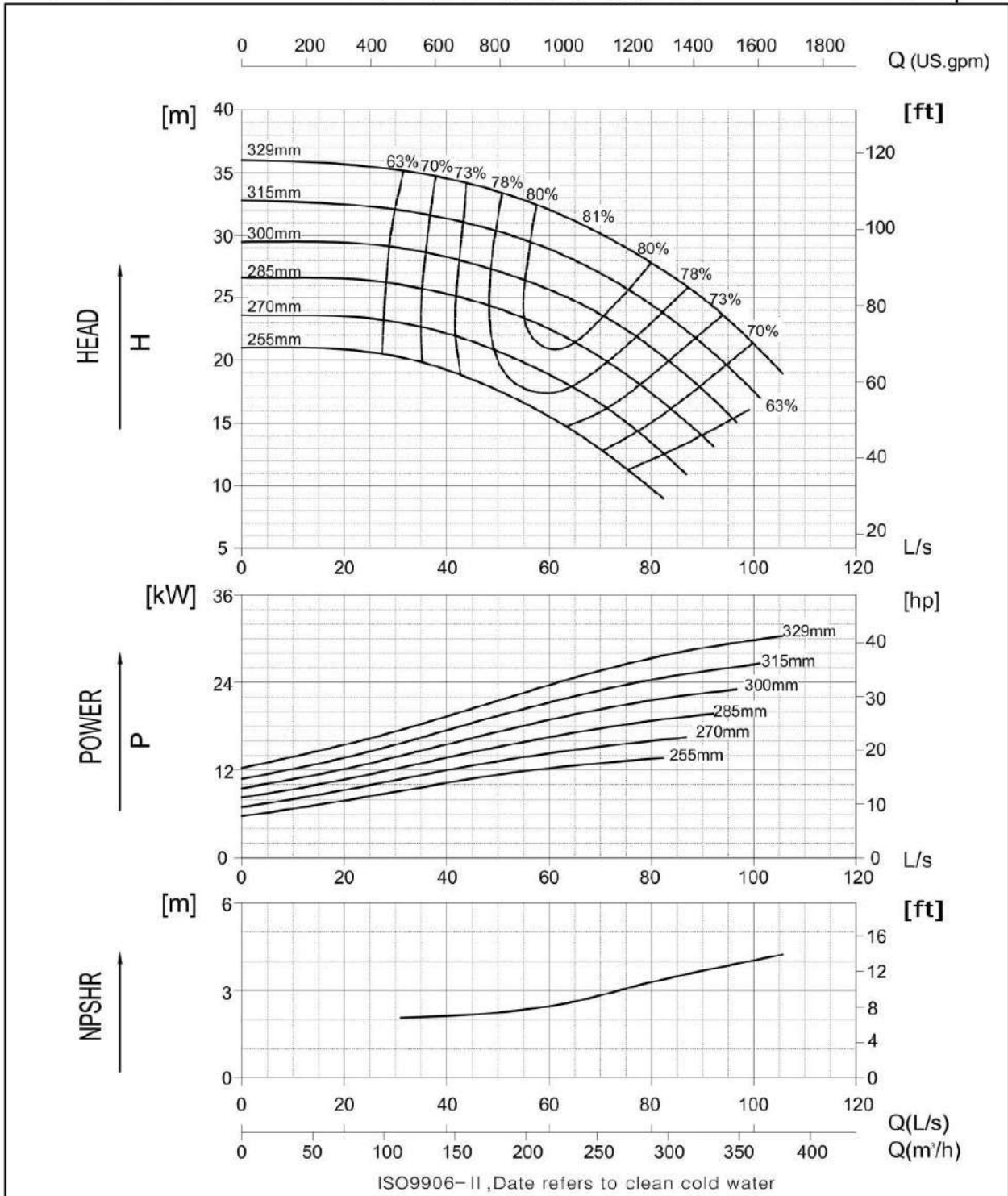

P1701A



BS EN 733/DIN 24255

150-125-400

Performance Curve

1450 rpm

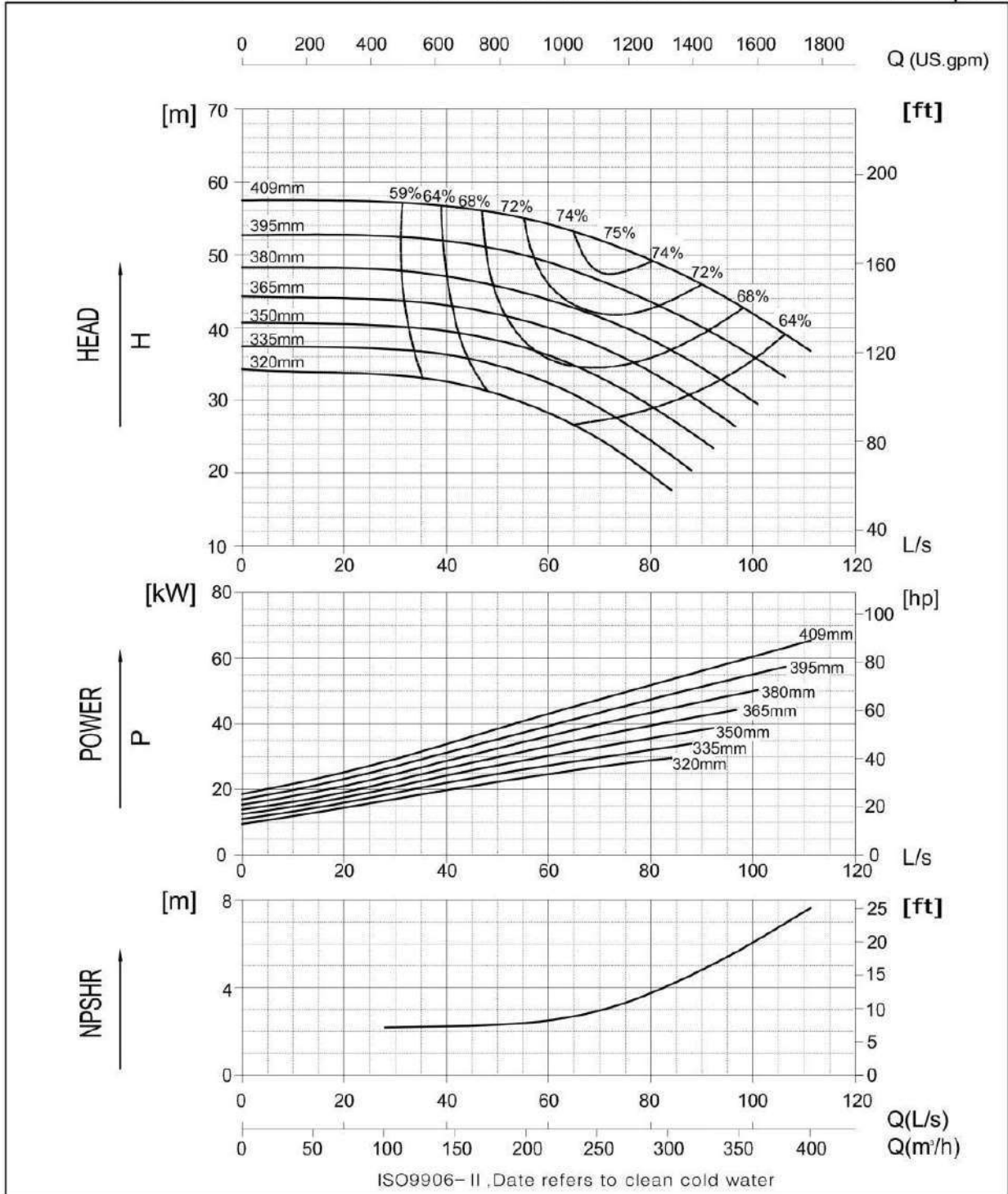

P1701A

BS EN 733/DIN 24255

200-150-200

Performance Curve

1450 rpm

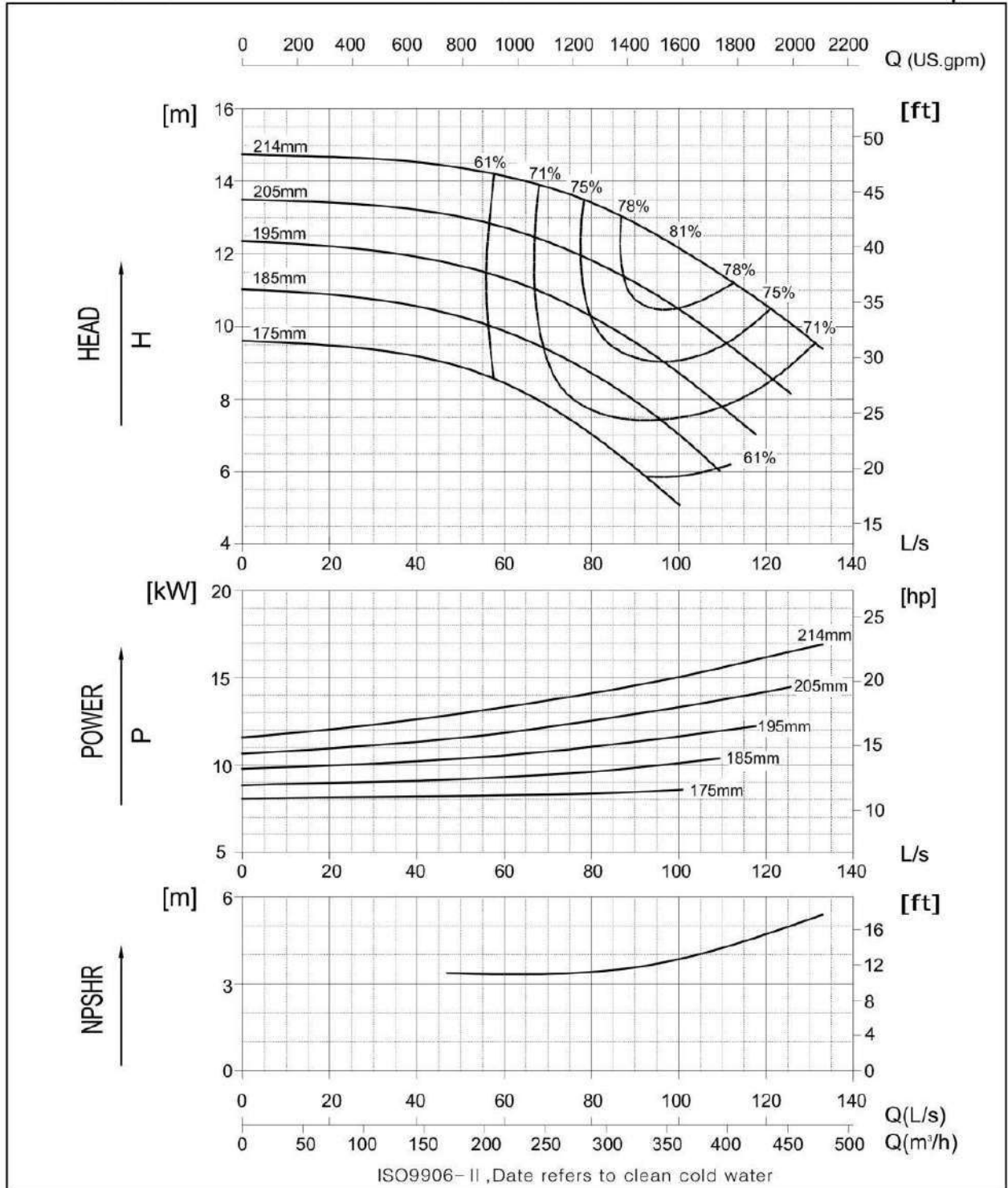

P1701A

BS EN 733/DIN 24255

200-150-260

Performance Curve

1450 rpm

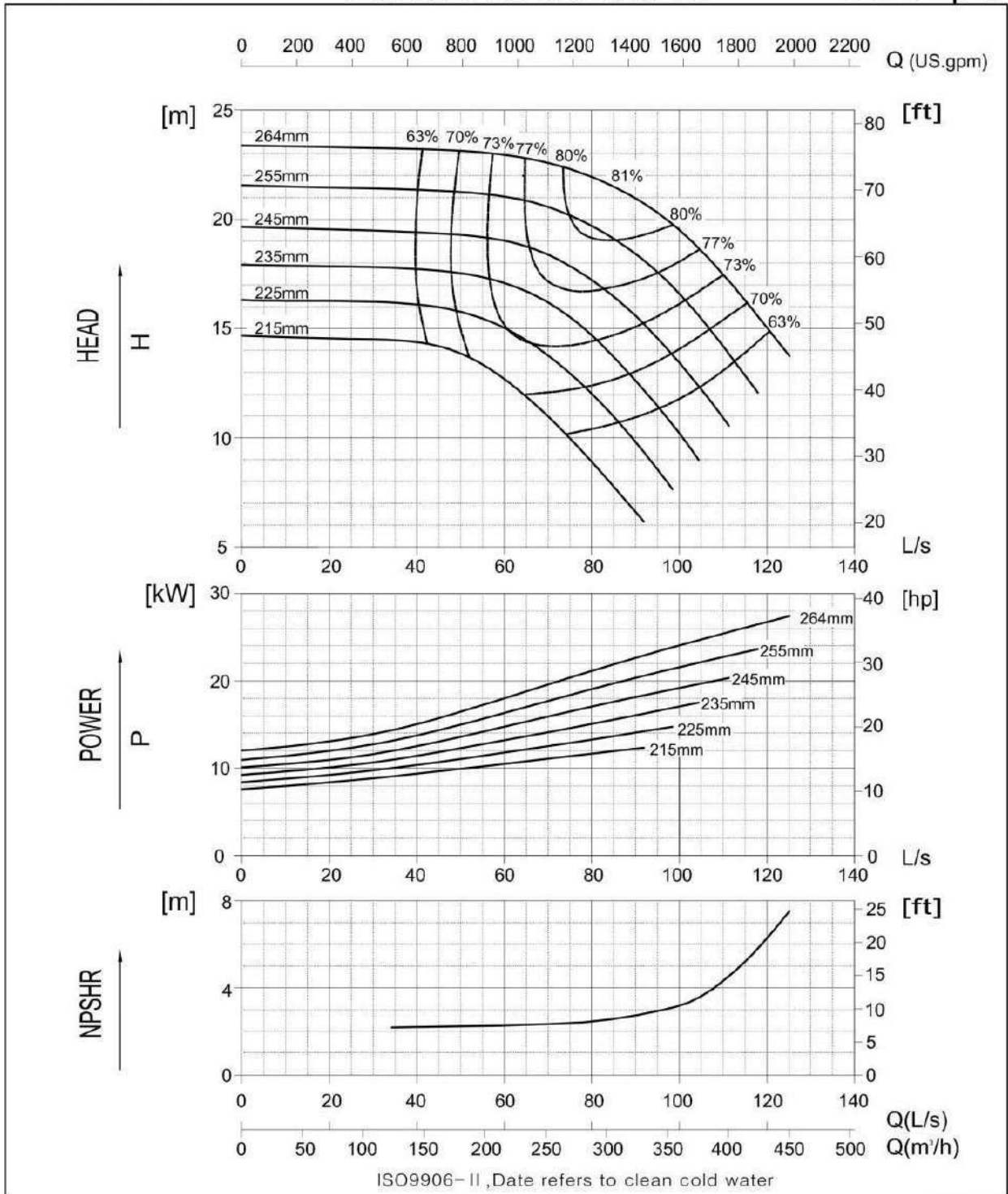

P1701A



BS EN 733/DIN 24255

200-150-320

Performance Curve

1450 rpm

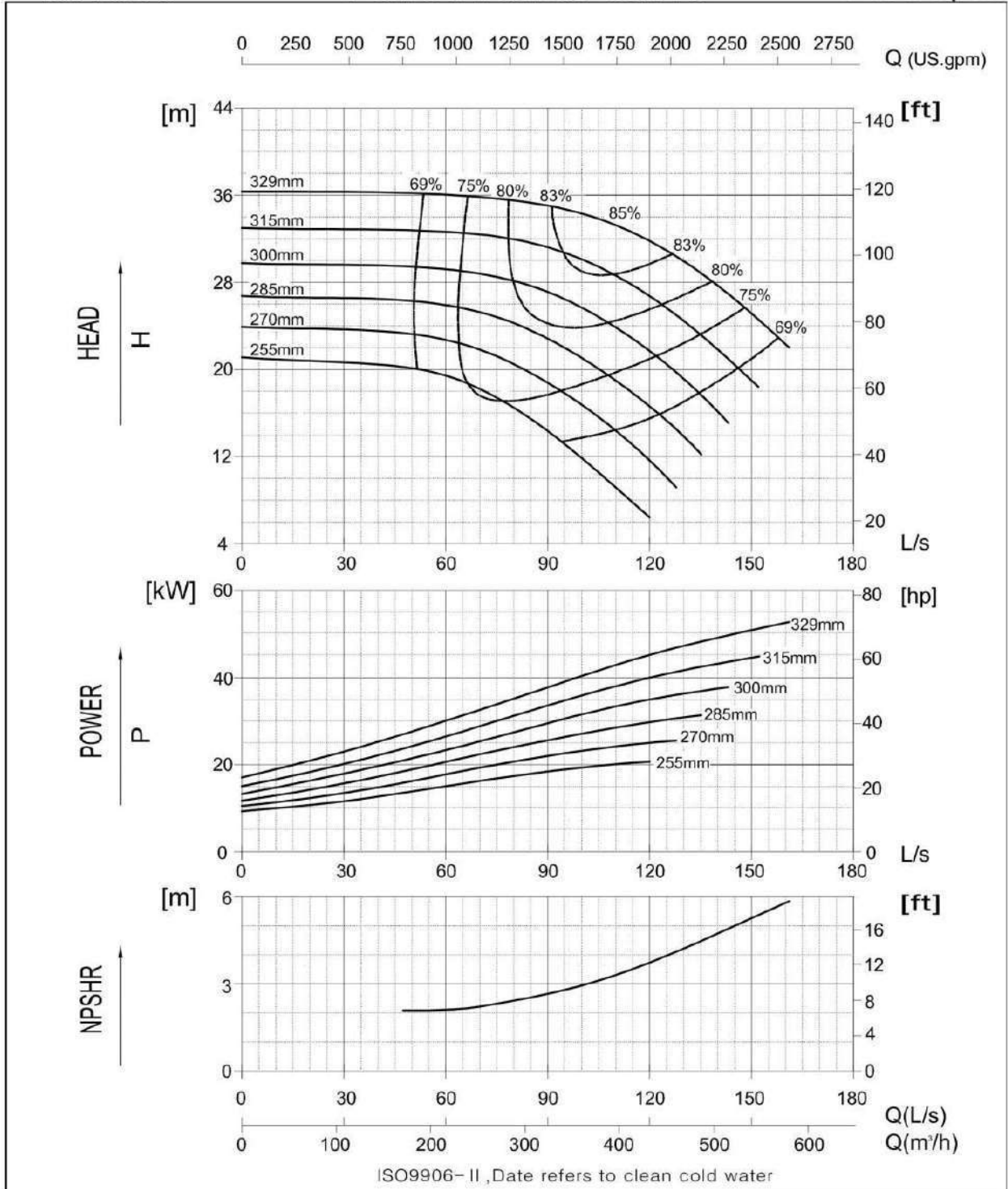

P1701A

BS EN 733/DIN 24255

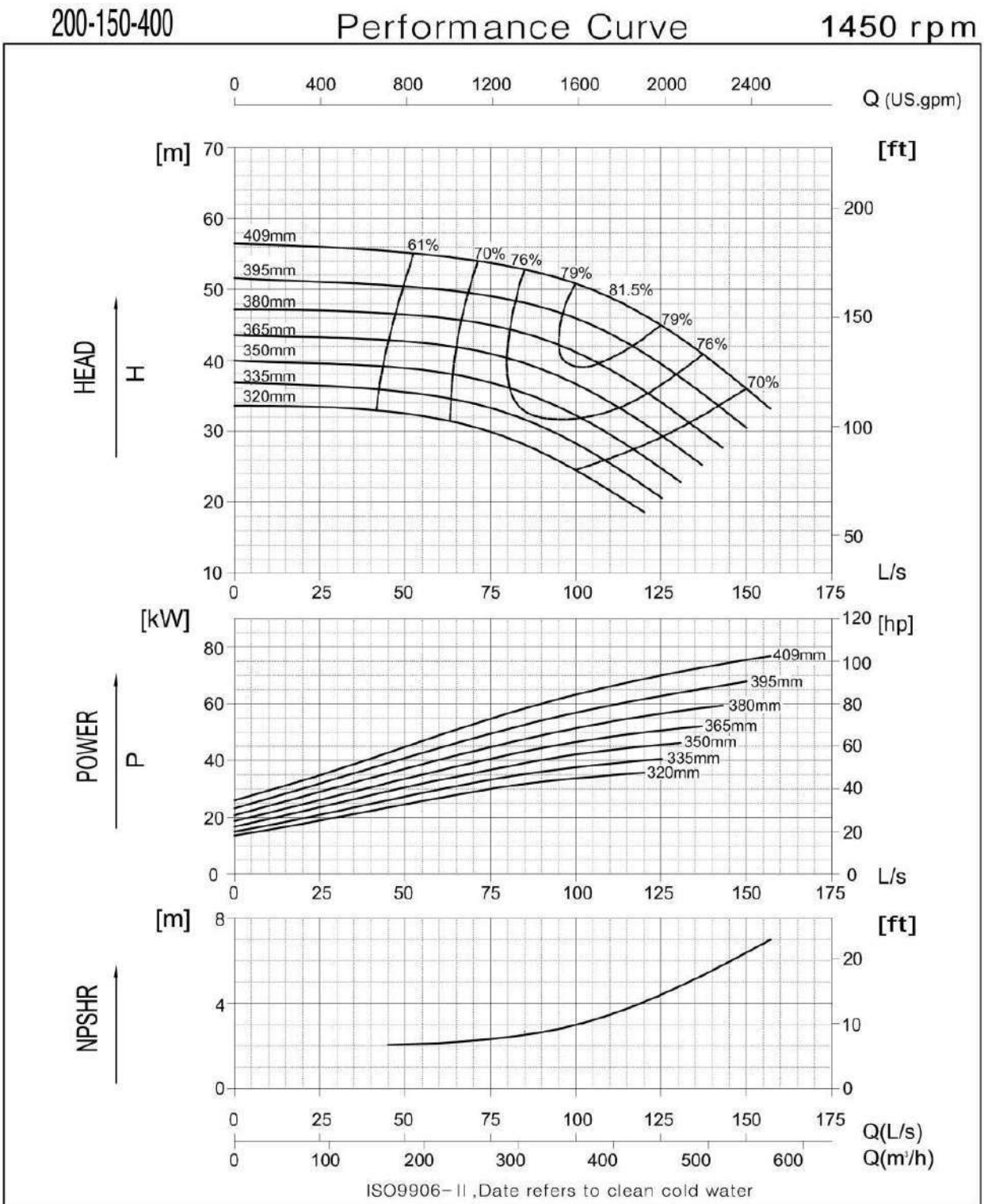

P1701A

BS EN 733/DIN 24255

250-200-260

Performance Curve

1450 rpm

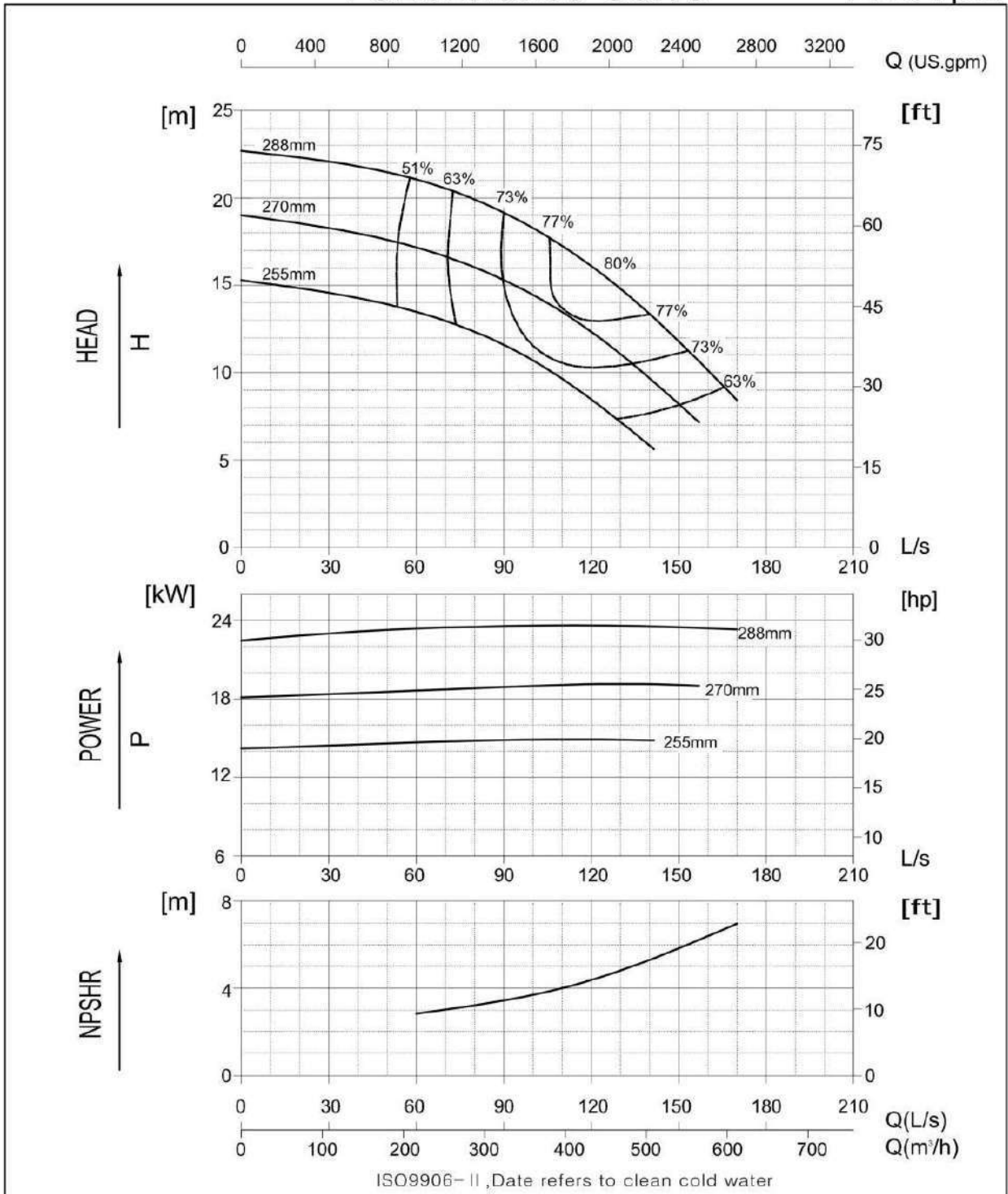

P1701A





BS EN 733/DIN 24255

250-200-320

Performance Curve

1450 rpm

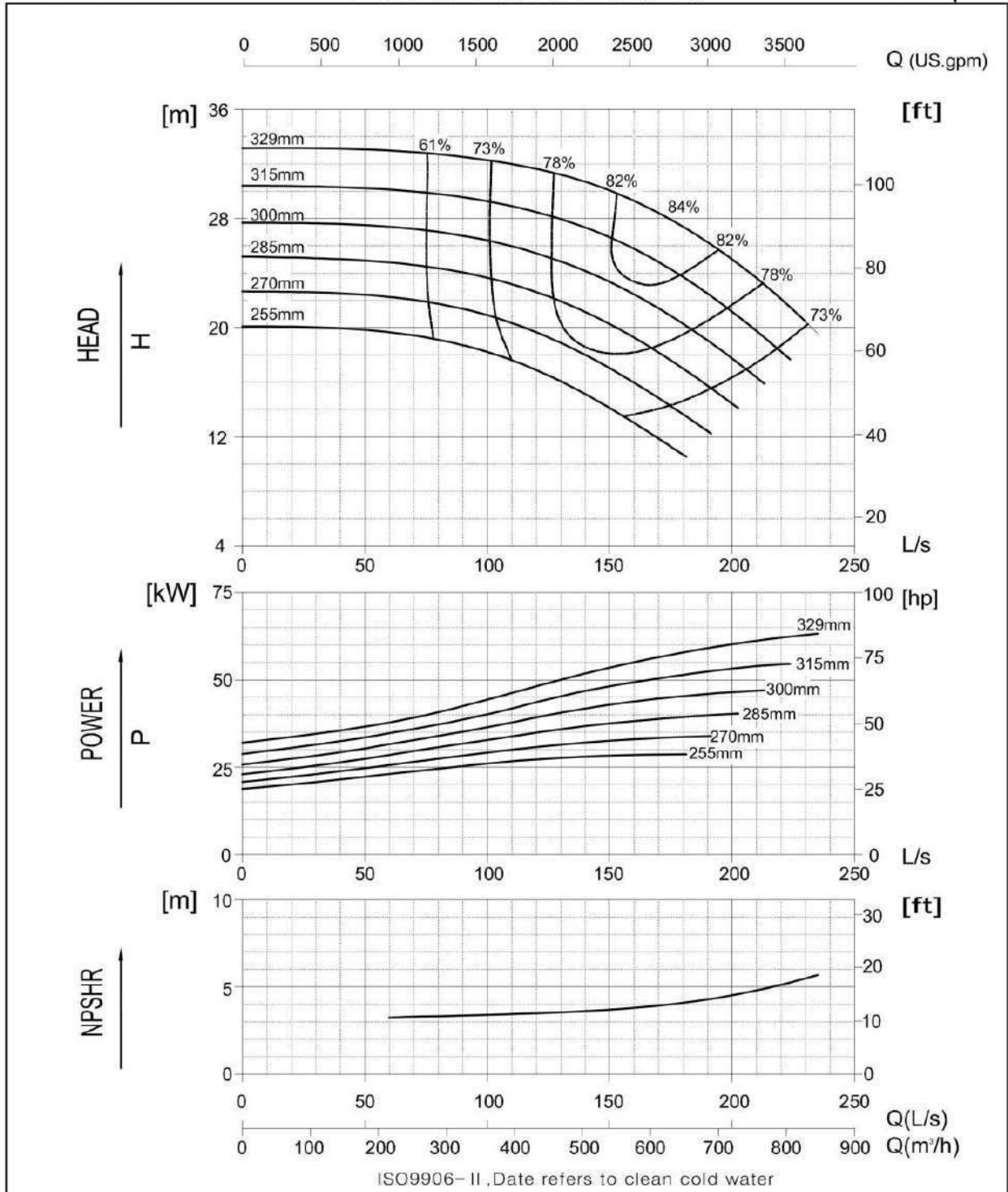

P1701A



BS EN 733/DIN 24255

250-200-400

Performance Curve

1450 rpm

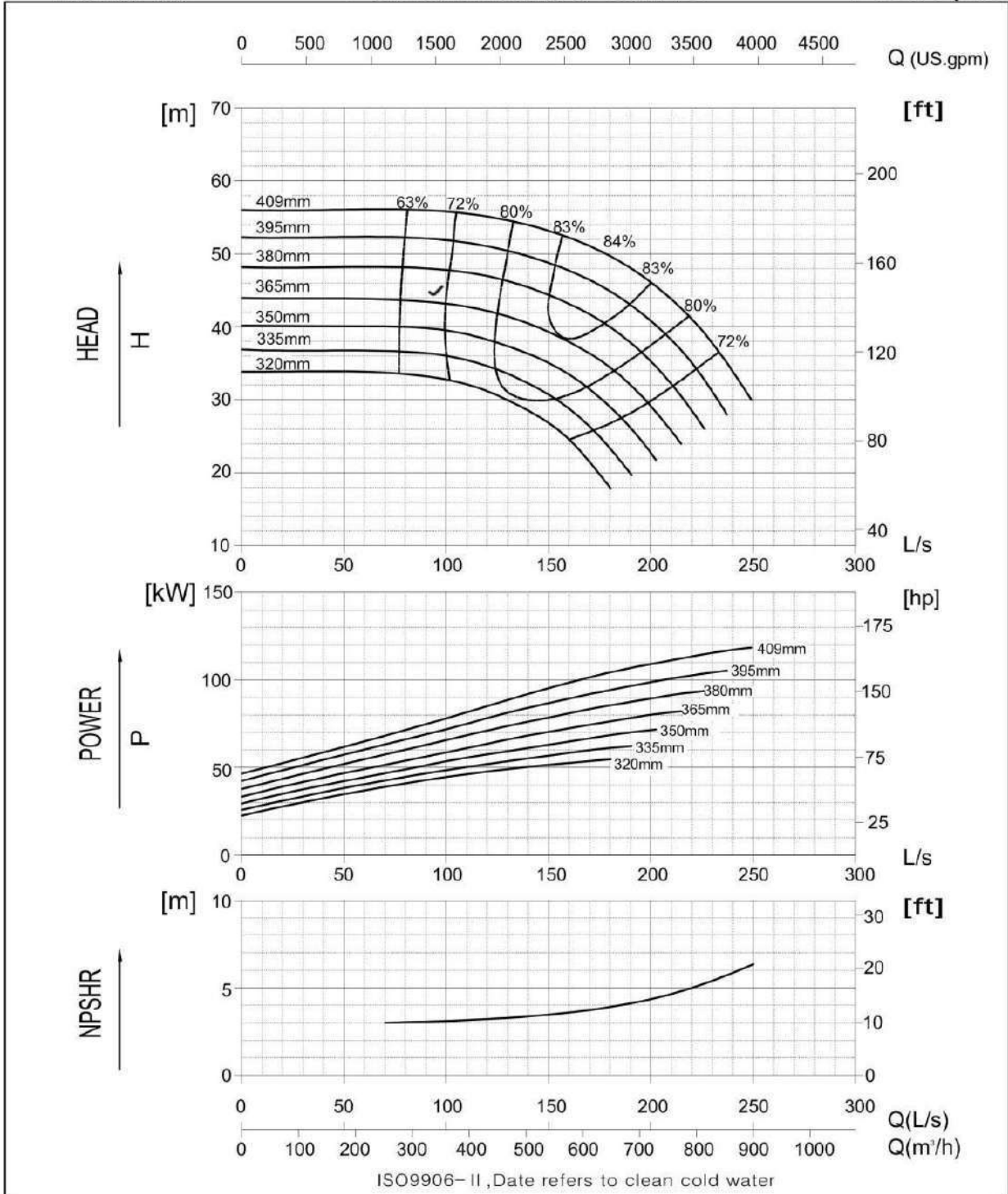

P1701A



BS EN 733/DIN 24255

300-250-320

Performance Curve

1450 rpm

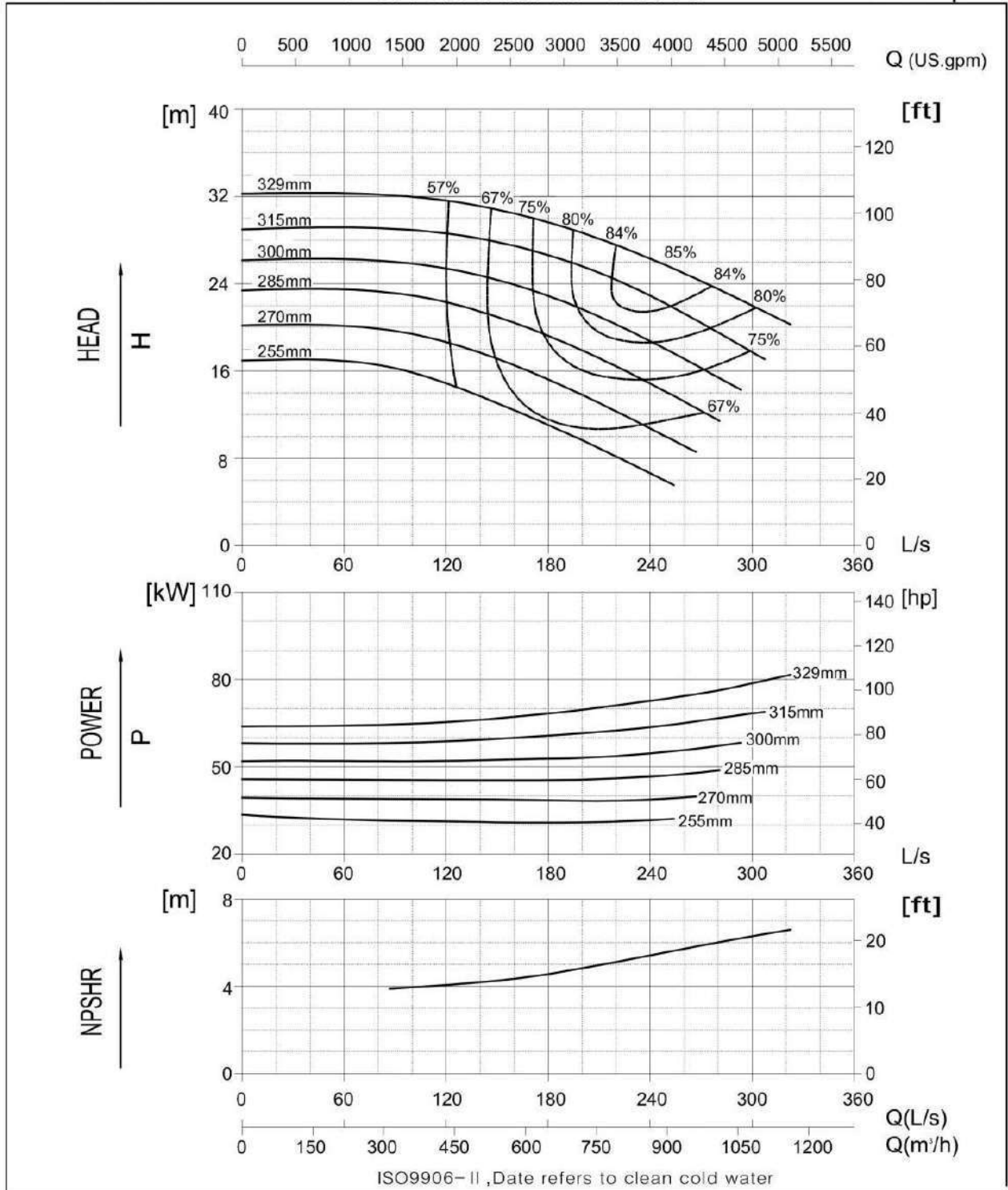

P1701A

BS EN 733/DIN 24255

300-250-400

Performance Curve

1450 rpm

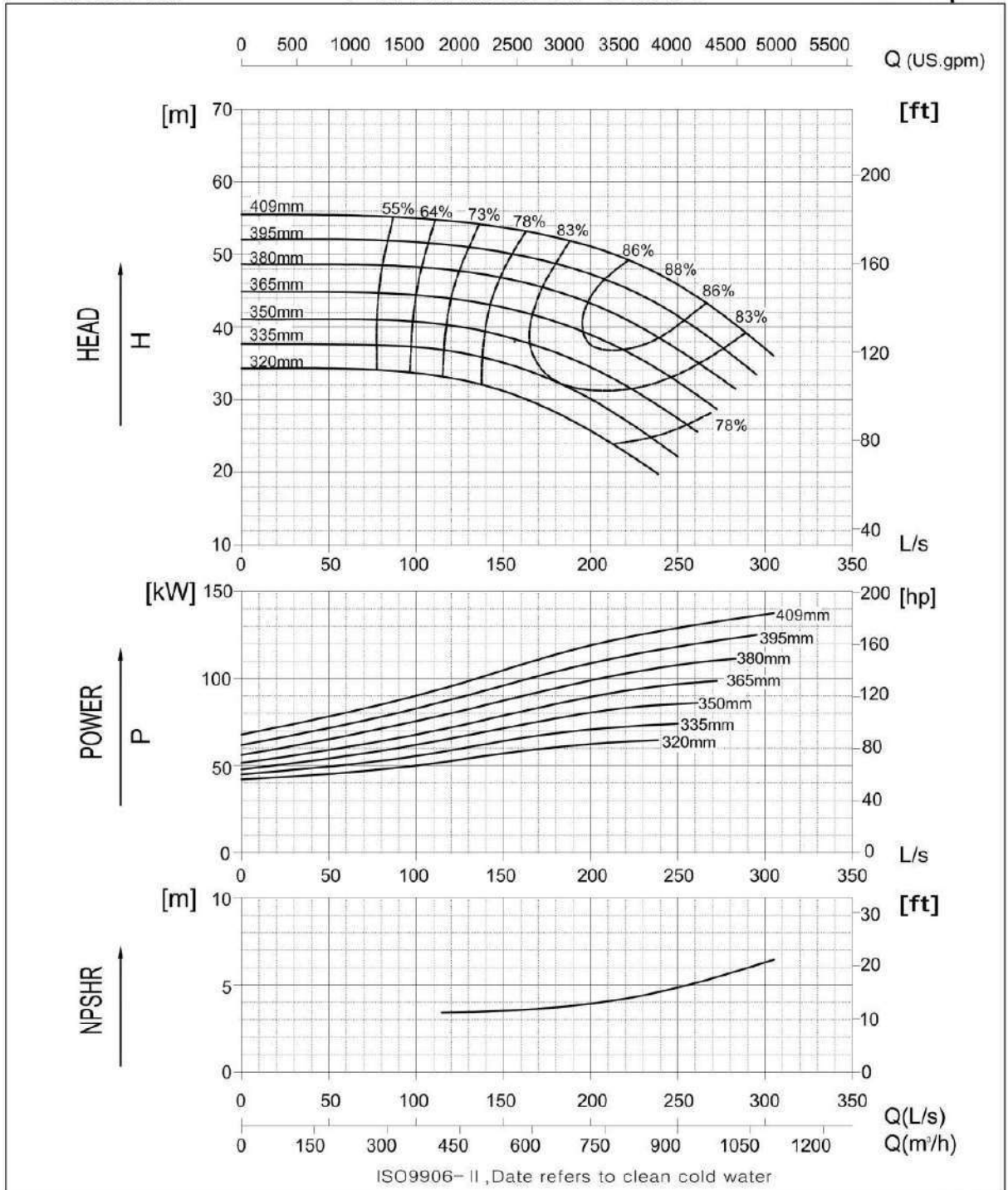

P1701A